

PROTEUS

The Complete Electronics Design System

Component Library Documentation

Issue 1.1 – Dated 01/July/2000
© Labcenter Electronics

Labcenter
Electronics



Description

This library contains general schematic symbols such as resistors, capacitors, diodes and transistors.

DEVICE.LIB also contains connector symbols for use on PCBs.

Contents

AERIAL	CONN-H2	DIODE-LED	NMOSFET	REL-SPM:A	SW-DIP8
BATTERY	CONN-H4	DIODE-SC	NPN	REL-SPM:B	SW-DPDT
BRIDGE	CONN-H5	DIODE-TUN	OPAMP	RELAY:A	SW-DPST
BUZZER	CONN-H6	DIODE-ZEN	PIN	RELAY:B	SW-SPDT
CAP	CONN-H10	FUSE	PJFET	RES	SW-SPST
CAP-ELEC	CONN-H12	IND-AIR	PMOSFET	RES-PRE	TERMINAL
CAP-POL	CONN-H15	IND-IRON	PNP	RES-VAR	THYRISTOR
CAP-PRE	CONN-H16	INDUCTOR	POT	RESPACK-7	TRAN-2P2S
CAP-VAR	CONN-H20	LAMP-FIL	POT-LIN	RESPACK-8	TRAN-2P3S
CELL	CONN-H32	LAMP-NEON	POT-LOG	SCR	TRAN-2P5S
CONN-D9	CRYSTAL	LED	PRESET	SPEAKER	TRIAC
CONN-D15	DIAC	METER	REG-NEG	SW-DIP4	VEROPIN
CONN-D25	DIODE	NJFET	REG-POS	SW-DIP7	

Notes

The generic parts such as NPN, PNP are unpackaged and are thus not intended for use on schematics where PCB manufacture is the end goal. This generic parts may of course be use as templates for specific device types.

The components have the appropriate properties for simulation where corresponding models exist.



Description

This library contains diodes and bridge rectifiers from a number of manufacturers. All the parts in this library are packaged for PCB design and have appropriate simulator properties and/or models although some of the models are generic to a particular category of diode – e.g. small signal switching diode.

Contents

1M110ZS5	1N977B	1N4744A	1N5242B	1N5335BRL	1N5379BRL
1M120ZS5	1N978B	1N4745A	1N5243B	1N5336BRL	1N5380BRL
1M130ZS5	1N979B	1N4746A	1N5244B	1N5337BRL	1N5381BRL
1M150ZS5	1N980B	1N4747A	1N5245A	1N5338BRL	1N5382BRL
1M160ZS5	1N981B	1N4748A	1N5245B	1N5339BRL	1N5383BRL
1M180ZS5	1N982B	1N4749A	1N5246B	1N5340BRL	1N5384BRL
1M200ZS5	1N983B	1N4750A	1N5247B	1N5341BRL	1N5385BRL
1N746A	1N984B	1N4751A	1N5248B	1N5342BRL	1N5386BRL
1N747A	1N985B	1N4751B	1N5249B	1N5343BRL	1N5387BRL
1N748A	1N986B	1N4752A	1N5250B	1N5344BRL	1N5388BRL
1N749A	1N987B	1N4753A	1N5251B	1N5345BRL	1N5400
1N750A	1N988B	1N4754A	1N5252B	1N5346BRL	1N5401
1N751A	1N989B	1N4755A	1N5253B	1N5347BRL	1N5402
1N752A	1N990B	1N4756A	1N5254B	1N5348BRL	1N5404
1N753A	1N991B	1N4757A	1N5255B	1N5349BRL	1N5406
1N754A	1N992B	1N4758A	1N5256B	1N5350BRL	1N5407
1N755A	1N4001	1N4759A	1N5257B	1N5351BRL	1N5408
1N756A	1N4002	1N4760A	1N5258B	1N5352BRL	1N5913B
1N757A	1N4003	1N4761A	1N5259B	1N5353BRL	1N5914B
1N758A	1N4004	1N4762A	1N5260B	1N5354BRL	1N5915B
1N759A	1N4005	1N4763A	1N5261B	1N5355BRL	1N5916B
1N914	1N4006	1N4764A	1N5262B	1N5356BRL	1N5917B
1N916	1N4007	1N5221B	1N5263B	1N5357BRL	1N5918B
1N957B	1N4148	1N5222B	1N5264B	1N5358BRL	1N5919B
1N958B	1N4370A	1N5223B	1N5265B	1N5359BRL	1N5920B
1N959B	1N4371A	1N5224B	1N5266B	1N5360BRL	1N5921B
1N960B	1N4372A	1N5225B	1N5267B	1N5361BRL	1N5922B
1N961B	1N4728A	1N5226B	1N5268B	1N5362BRL	1N5923B
1N962B	1N4729A	1N5227B	1N5269B	1N5363BRL	1N5924B
1N963B	1N4730A	1N5228B	1N5270B	1N5364BRL	1N5925B
1N964B	1N4731A	1N5229B	1N5271B	1N5365BRL	1N5926B
1N965B	1N4732A	1N5230B	1N5272B	1N5366BRL	1N5927B
1N966B	1N4733A	1N5231B	1N5273B	1N5367BRL	1N5928B
1N967B	1N4734A	1N5232B	1N5274B	1N5368BRL	1N5929B
1N968B	1N4735A	1N5233B	1N5275B	1N5369BRL	1N5930B
1N969B	1N4736A	1N5234B	1N5276B	1N5370BRL	1N5931B
1N970B	1N4737A	1N5235B	1N5277B	1N5371BRL	1N5932B
1N971B	1N4738A	1N5236B	1N5278B	1N5372BRL	1N5933B
1N972B	1N4739A	1N5237B	1N5279B	1N5373BRL	1N5934B
1N973B	1N4740A	1N5238B	1N5280B	1N5374BRL	1N5935B
1N974B	1N4741A	1N5239B	1N5281B	1N5375BRL	1N5936B
1N975B	1N4742A	1N5240B	1N5333BRL	1N5377BRL	1N5937B
1N976B	1N4743A	1N5241B	1N5334BRL	1N5378BRL	1N5938B

1N5939B	1N6025B	BAR28	BZV85C5V1	BZX55C6V2	BZX79C3V6RL
1N5940B	3EZ3V9D5	BAX13	BZV85C5V6	BZX55C6V2RL	BZX79C3V9
1N5941B	3EZ4V3D5	BAX16	BZV85C6V2	BZX55C6V8	BZX79C3V9RL
1N5942B	3EZ4V7D5	BB212	BZV85C6V8	BZX55C6V8RL	BZX79C4V3
1N5943B	3EZ5V1D5	BY127	BZV85C7V5	BZX55C7V5	BZX79C4V3RL
1N5944B	3EZ5V6D5	BY206	BZV85C8V2	BZX55C7V5RL	BZX79C4V7
1N5945B	3EZ6V2D5	BYT30	BZV85C9V1	BZX55C8V2	BZX79C4V7RL
1N5946B	3EZ6V8D5	BYW51	BZV85C10	BZX55C8V2RL	BZX79C5V1
1N5947B	3EZ7V5D5	BYW80	BZV85C12	BZX55C9V1	BZX79C5V1RL
1N5948B	3EZ8V2D5	BYW98	BZV85C13	BZX55C9V1RL	BZX79C5V6
1N5949B	3EZ9V1D5	BZG03C10	BZV85C15	BZX55C10	BZX79C5V6RL
1N5950B	3EZ10D5	BZG03C12	BZV85C16	BZX55C10RL	BZX79C6V2
1N5951B	3EZ11D5	BZG03C15	BZV85C18	BZX55C11	BZX79C6V2RL
1N5952B	3EZ12D5	BZG03C18	BZV85C20	BZX55C11RL	BZX79C6V8
1N5953B	3EZ13D5	BZG03C20	BZV85C22	BZX55C12	BZX79C6V8RL
1N5954B	3EZ14D5	BZG03C24	BZV85C24	BZX55C12RL	BZX79C7V5
1N5955B	3EZ15D5	BZG03C30	BZV85C27	BZX55C13	BZX79C7V5RL
1N5956B	3EZ16D5	BZG03C33	BZV85C30	BZX55C13RL	BZX79C8V2
1N5985B	3EZ17D5	BZG03C56	BZV85C33	BZX55C15	BZX79C8V2RL
1N5986B	3EZ18D5	BZG03C100	BZV85C36	BZX55C15RL	BZX79C9V1
1N5987B	3EZ19D5	BZG03C150	BZV85C39	BZX55C16	BZX79C9V1RL
1N5988B	3EZ20D5	BZG03C180	BZV85C43	BZX55C16RL	BZX79C10
1N5989B	3EZ22D5	BZT03C	BZV85C47	BZX55C18	BZX79C10RL
1N5990B	3EZ24D5	BZT03C7V5	BZV85C51	BZX55C18RL	BZX79C11
1N5991B	3EZ27D5	BZT03C8V2	BZV85C56	BZX55C20	BZX79C11RL
1N5992B	3EZ28D5	BZT03C9V1	BZV85C62	BZX55C20RL	BZX79C12
1N5993B	3EZ30D5	BZT03C10	BZV85C68	BZX55C22	BZX79C12RL
1N5994B	3EZ33D5	BZT03C12	BZV85C75	BZX55C22RL	BZX79C13
1N5995B	3EZ36D5	BZT03C15	BZV90C5V1	BZX55C24	BZX79C13RL
1N5996B	3EZ39D5	BZT03C16	BZV90C5V6	BZX55C24RL	BZX79C15
1N5997B	3EZ43D5	BZT03C18	BZV90C6V2	BZX55C27	BZX79C15RL
1N5998B	3EZ47D5	BZT03C20	BZV90C6V8	BZX55C27RL	BZX79C16
1N5999B	3EZ51D5	BZT03C22	BZV90C8V2	BZX55C30	BZX79C16RL
1N6000B	3EZ56D5	BZT03C24	BZV90C10	BZX55C30RL	BZX79C18
1N6001B	3EZ62D5	BZT03C27	BZV90C12	BZX55C33	BZX79C18RL
1N6002B	3EZ68D5	BZT03C30	BZV90C15	BZX55C33RL	BZX79C20
1N6003B	3EZ75D5	BZT03C33	BZV90C16	BZX55C36RL	BZX79C20RL
1N6004B	3EZ82D5	BZT03C36	BZV90C18	BZX55C39RL	BZX79C22
1N6005B	3EZ91D5	BZT03C39	BZV90C20	BZX55C43RL	BZX79C22RL
1N6006B	3EZ100D5	BZT03C43	BZV90C27	BZX55C47RL	BZX79C24
1N6007B	3EZ110D5	BZT03C47	BZX55C	BZX55C51RL	BZX79C24RL
1N6008B	3EZ120D5	BZT03C51	BZX55C2V4RL	BZX55C56RL	BZX79C27
1N6009B	3EZ130D5	BZT03C56	BZX55C2V7RL	BZX55C62RL	BZX79C27RL
1N6010B	3EZ140D5	BZT03C62	BZX55C3V0RL	BZX55C68RL	BZX79C30
1N6011B	3EZ150D5	BZT03C68	BZX55C3V3	BZX55C75RL	BZX79C30RL
1N6012B	3EZ160D5	BZT03C75	BZX55C3V3RL	BZX55C82RL	BZX79C33
1N6013B	3EZ170D5	BZT03C82	BZX55C3V6	BZX55C91RL	BZX79C33RL
1N6014B	3EZ180D5	BZT03C91	BZX55C3V6RL	BZX61C	BZX79C36
1N6015B	3EZ190D5	BZT03C100	BZX55C3V9	BZX79C	BZX79C36RL
1N6016B	3EZ200D5	BZT03C120	BZX55C3V9RL	BZX79C2V4	BZX79C39
1N6017B	3EZ220D5	BZT03C130	BZX55C4V3	BZX79C2V4RL	BZX79C39RL
1N6018B	3EZ240D5	BZT03C150	BZX55C4V3RL	BZX79C2V7	BZX79C43RL
1N6019B	3EZ270D5	BZT03C160	BZX55C4V7	BZX79C2V7RL	BZX79C47
1N6020B	3EZ300D5	BZT03C180	BZX55C4V7RL	BZX79C3V0	BZX79C47RL
1N6021B	3EZ330D5	BZT03C200	BZX55C5V1	BZX79C3V0RL	BZX79C51RL
1N6022B	3EZ360D5	BZT03C220	BZX55C5V1RL	BZX79C3V3	BZX79C56
1N6023B	3EZ400D5	BZT03C270	BZX55C5V6	BZX79C3V3RL	BZX79C56RL
1N6024B	AA119	BZV85C	BZX55C5V6RL	BZX79C3V6	BZX79C62RL

BZX79C68RL	BZX84C15	BZX85C30	MMBZ5236B	MZD33	MZPY4V3RL
BZX79C75	BZX84C16	BZX85C30RL	MMBZ5237B	MZD36	MZPY4V7RL
BZX79C75RL	BZX84C18	BZX85C33	MMBZ5238B	MZD39	MZPY5V1RL
BZX79C82RL	BZX84C20	BZX85C33RL	MMBZ5239B	MZD43	MZPY5V6RL
BZX79C91RL	BZX84C22	BZX85C36RL	MMBZ5240B	MZD47	MZPY6V2RL
BZX79C100RL	BZX84C24	BZX85C39RL	MMBZ5241B	MZD51	MZPY6V8RL
BZX79C110RL	BZX84C27	BZX85C43RL	MMBZ5242B	MZD56	MZPY7V5RL
BZX79C120RL	BZX84C30	BZX85C47RL	MMBZ5243B	MZD62	MZPY8V2RL
BZX79C130RL	BZX84C33	BZX85C51RL	MMBZ5244B	MZD68	MZPY9V1RL
BZX79C150RL	BZX84C36	BZX85C56RL	MMBZ5245B	MZD75	MZPY10RL
BZX79C160RL	BZX84C47	BZX85C62RL	MMBZ5246B	MZD82	MZPY11RL
BZX79C180RL	BZX85C	BZX85C68RL	MMBZ5247B	MZD91	MZPY12RL
BZX79C200RL	BZX85C3V3	BZX85C75RL	MMBZ5248B	MZD100	MZPY13RL
BZX83C2V7RL	BZX85C3V3RL	BZX85C82RL	MMBZ5249B	MZD110	MZPY15RL
BZX83C3V0RL	BZX85C3V6	BZX85C91RL	MMBZ5250B	MZD120	MZPY16RL
BZX83C3V3RL	BZX85C3V6RL	BZX85C100RL	MMBZ5251B	MZD130	MZPY18RL
BZX83C3V6RL	BZX85C3V9	BZX284C2V4	MMBZ5252B	MZD150	MZPY20RL
BZX83C3V9RL	BZX85C3V9RL	BZX284C2V7	MMBZ5253B	MZD160	MZPY22RL
BZX83C4V3RL	BZX85C4V3	BZX284C3V0	MMBZ5254B	MZD180	MZPY24RL
BZX83C4V7RL	BZX85C4V3RL	BZX284C3V3	MMBZ5255B	MZD200	MZPY27RL
BZX83C5V1RL	BZX85C4V7	BZX284C3V6	MMBZ5256B	MZP4728A	MZPY30RL
BZX83C5V6RL	BZX85C4V7RL	BZX284C3V9	MMBZ5257B	MZP4729A	MZPY33RL
BZX83C6V2RL	BZX85C5V1	BZX284C4V3	MR751	MZP4730A	MZPY36RL
BZX83C6V8RL	BZX85C5V1RL	BZX284C4V7	MR754	MZP4731A	MZPY39RL
BZX83C7V5RL	BZX85C5V6	BZX284C5V1	MV2108	MZP4732A	MZPY43RL
BZX83C8V2RL	BZX85C5V6RL	BZX284C5V6	MZ5520B	MZP4733A	MZPY47RL
BZX83C9V1RL	BZX85C6V2	BZX284C6V2	MZ5521B	MZP4734A	MZPY51RL
BZX83C10RL	BZX85C6V2RL	BZX284C6V8	MZ5522B	MZP4735A	MZPY56RL
BZX83C11RL	BZX85C6V8	BZX284C7V5	MZ5523B	MZP4736A	MZPY62RL
BZX83C12RL	BZX85C6V8RL	BZX284C8V2	MZ5524B	MZP4737A	MZPY68RL
BZX83C13RL	BZX85C7V5	BZX284C9V1	MZ5525B	MZP4738A	MZPY75RL
BZX83C15RL	BZX85C7V5RL	BZX284C10	MZ5526B	MZP4739A	MZPY82RL
BZX83C16RL	BZX85C8V2	BZX284C11	MZ5527B	MZP4740A	MZPY91RL
BZX83C18RL	BZX85C8V2RL	BZX284C12	MZ5528B	MZP4741A	MZPY100RL
BZX83C20RL	BZX85C9V1	BZX284C13	MZ5529B	MZP4742A	OA47
BZX83C22RL	BZX85C9V1RL	BZX284C15	MZ5530B	MZP4743A	OA90
BZX83C24RL	BZX85C10	BZX284C16	MZD3V9	MZP4744A	OA91
BZX83C27RL	BZX85C10RL	BZX284C18	MZD4V3	MZP4745A	OA95
BZX83C30RL	BZX85C11	BZX284C20	MZD4V7	MZP4746A	OA202
BZX83C33RL	BZX85C11RL	BZX284C22	MZD5V1	MZP4747A	P600
BZX84C2V4	BZX85C12	BZX284C24	MZD5V6	MZP4748A	PW01
BZX84C2V7	BZX85C12RL	BZX284C27	MZD6V2	MZP4749A	PW06
BZX84C3V0	BZX85C13	BZX284C30	MZD6V8	MZP4750A	S04
BZX84C3V3	BZX85C13RL	BZX284C33	MZD7V5	MZP4751A	S005
BZX84C3V9	BZX85C15	BZY88C	MZD8V2	MZP4752A	SK202L5
BZX84C4V3	BZX85C15RL	GBPC802	MZD9V1	MZP4753A	SK204L5
BZX84C4V7	BZX85C16	GBPC804	MZD10	MZP4754A	UF4001
BZX84C5V1	BZX85C16RL	GBPC808	MZD11	MZP4755A	UF4002
BZX84C5V6	BZX85C18	MMBZ5226B	MZD12	MZP4756A	UF4003
BZX84C6V2	BZX85C18RL	MMBZ5227B	MZD13	MZP4757A	UF4004
BZX84C6V8	BZX85C20	MMBZ5228B	MZD15	MZP4758A	UF5400
BZX84C7V5	BZX85C20RL	MMBZ5229B	MZD16	MZP4759A	UF5401
BZX84C8V2	BZX85C22	MMBZ5230B	MZD18	MZP4760A	UF5402
BZX84C9V1	BZX85C22RL	MMBZ5231B	MZD20	MZP4761A	UF5404
BZX84C10	BZX85C24	MMBZ5232B	MZD22	MZP4762A	UF5406
BZX84C11	BZX85C24RL	MMBZ5233B	MZD24	MZP4763A	W01
BZX84C12	BZX85C27	MMBZ5234B	MZD27	MZP4764A	W02
BZX84C13	BZX85C27RL	MMBZ5235B	MZD30	MZPY3V9RL	W04

W005	ZPD3V9RL	ZPD6V2RL	ZPD10RL	ZPD16RL	ZPD27RL
ZPD2V7RL	ZPD4V3RL	ZPD6V8RL	ZPD11RL	ZPD18RL	ZPD30RL
ZPD3V0RL	ZPD4V7RL	ZPD7V5RL	ZPD12RL	ZPD20RL	ZPD33RL
ZPD3V3RL	ZPD5V1RL	ZPD8V2RL	ZPD13RL	ZPD22RL	
ZPD3V6RL	ZPD5V6RL	ZPD9V1RL	ZPD15RL	ZPD24RL	



Description

This library contains bipolar transistors from a number of manufacturers. All the parts in this library are packaged for PCB design and have appropriate simulator properties and/or models although some of the models are generic to a particular category of transistor – e.g. small signal low frequency.

Contents

2N697	2N5551	BC213	BD712	MJ15004	ZTX107
2N706	2N6545	BC214	BD743	MJE340	ZTX108
2N1711	2N6547	BC237	BD911	MJE350	ZTX109
2N1893	2N6609	BC239	BD912	MJE13005	ZTX300
2N2219	2SA715	BC301	BDX53	MJE13007	ZTX302
2N2222	2SA872	BC303	BDX54	MPS3638	ZTX304
2N2369	2SA1085	BC327	BF173	MPSA14	ZTX313
2N2905	2SB716	BC328	BF180	MPSA42	ZTX450
2N2907	2SB718	BC337	BF259	MPSA65	ZTX451
2N2926	2SC1162	BC338	BF337	MPSA92	ZTX453
2N3019	2SC2547	BC441	BF494	MPSH10	ZTX455
2N3053	2SD756	BC461	BFY50	TIP31	ZTX500
2N3054	2SD758	BC478	BFY51	TIP32	ZTX502
2N3055	AC127	BC547	BFY52	TIP33	ZTX504
2N3702	AC128	BC548	BFY90	TIP34	ZTX541
2N3703	BC107	BC549	BSX20	TIP35	ZTX542
2N3704	BC108	BC550	BU208	TIP36	ZTX550
2N3705	BC109	BC557	BU407	TIP41	ZTX551
2N3706	BC140	BC558	BU426	TIP42	ZTX650
2N3707	BC141	BC559	BU806	TIP47	ZTX651
2N3708	BC142	BC560	BUP35	TIP122	ZTX652
2N3711	BC143	BCY70	BUP41	TIP127	ZTX653
2N3771	BC160	BCY71	BUP49	TIP142	ZTX689
2N3772	BC161	BD131	BUP52	TIP147	ZTX704
2N3773	BC168	BD132	BUV46	TIP2955	ZTX750
2N3866	BC169	BD135	BUV47	TIP3055	ZTX751
2N3903	BC171	BD136	BUV48	TIPL760	ZTX752
2N3904	BC177	BD139	BUW49	TIPL762	ZTX753
2N3905	BC178	BD140	MJ423	TIPL763	ZTX851
2N3906	BC179	BD437	MJ2501	TIPL770	ZTX853
2N4401	BC182	BD438	MJ2955	TIPL791	ZTX857
2N4427	BC183	BD539	MJ3001	TIPP31	
2N5401	BC184	BD540	MJ11015	TIPP32	
2N5415	BC212	BD711	MJ11016	TIPP112	



Description

This library contains field effect transistors (JFETs and MOSFETs) from a number of manufacturers. All the parts in this library are packaged for PCB design and have appropriate simulator properties and/or models although some of the models are generic to a particular category of transistor – e.g. small signal low frequency.

Contents

2N3819	2SK133	BUK456	IRF520	IRF820	MPF102
2N5459	2SK134	BUZ10	IRF530	IRF830	MTH40N06
2N5460	2SK135	BUZ11	IRF540	IRF840	SMP60N06
2SJ48	2SK176	BUZ20	IRF620	IRF9520	SNW60N10
2SJ49	2SK413	BUZ21	IRF630	IRF9530	VN10
2SJ50	2SK1058	BUZ31	IRF640	IRFP250	VN66
2SJ56	BF244	IRF130	IRF720	IRFP450	VN121
2SJ118	BUK453	IRF330	IRF730	J109	
2SJ162	BUK455	IRF510	IRF740	J112	



Description

This library contains both specific and generic symbols for thermionic valves. The parts are not packaged for PCB since we have been unable to locate a reliable source of mechanical data, but most of the specific types are linked to SPICE models.

Contents

5AR4	6DJ8	12AX7	ECC83	EL84
5U4GB	6L6GC	12BH7	ECC88	GZ34
5V3A	6V6GTA	DIODE	ECF82	KT88
5V4GA	12AT7	ECC81	EF86	PENTODE
5Y3GT	12AU7	ECC82	EL34	TRIODE

Notes

We have chosen to draw dual valve types as single element parts because of the difficulties that arise with common heaters and in some cases cathode pins. Circuit simulations may fail if unused parts of the valves are not connected to ground.

We have not provided models for the valve heaters.



Description

This library contains standard TTL parts from the 74 series. All the parts are packaged for through hole PCB layout and most have corresponding simulator models. De Morgan (negative logic) and IEC versions are provided where appropriate.

Contents

7400	7416 .IEC	7446 .IEC	74122	74163	74199
7400 .DM	7417	7447	74122 .IEC	74163 .IEC	74221
7400 .IEC	7417 .DM	7447 .IEC	74123	74164 .IEC	74221 .IEC
7401	7417 .IEC	7448	74123 .IEC	74165	74247
7401 .DM	7420	7448 .IEC	74125	74165 .IEC	74248
7401 .IEC	7420 .DM	7450	74125 .DM	74166	74249
7402	7420 .IEC	7451	74125 .IEC	74166 .IEC	74251
7402 .DM	7422	7451 .IEC	74126	74167	74251 .IEC
7402 .IEC	7422 .DM	7454	74126 .DM	74170	74259
7403	7422 .IEC	7470	74126 .IEC	74173	74259 .IEC
7403 .IEC	7425	7470 .IEC	74128	74173 .IEC	74273
7404	7425 .DM	7472	74128 .DM	74174	74273 .IEC
7404 .DM	7426	7472 .IEC	74128 .IEC	74174 .IEC	74276
7404 .IEC	7426 .DM	7473	74132	74175	74276 .IEC
7405	7426 .IEC	7473 .IEC	74132 .DM	74175 .IEC	74279
7405 .DM	7427	7474	74132 .IEC	74176	74279 .IEC
7405 .IEC	7427 .DM	7474 .IEC	74136	74177	74283
7406	7427 .IEC	7475	74136 .IEC	74178	74283 .IEC
7406 .DM	7430	7475 .IEC	74141	74179	74284
7406 .IEC	7430 .DM	7476	74145	74180	74284 .IEC
7407	7430 .IEC	7476 .IEC	74147	74181	74285
7407 .DM	7432	7482	74147 .IEC	74181 .IEC	74285 .IEC
7407 .IEC	7432 .DM	7483	74148	74182	74290
7408	7432 .IEC	7485	74148 .IEC	74182 .IEC	74298
7408 .DM	7433	7485 .IEC	74150	74184	74298 .IEC
7408 .IEC	7433 .DM	7486	74151	74185	74365
7409	7433 .IEC	7486 .IEC	74151 .IEC	74190	74365 .IEC
7409 .DM	7437	7490	74153	74190 .IEC	74366
7409 .IEC	7437 .DM	7491	74153 .IEC	74191	74366 .IEC
7410	7437 .IEC	7492	74154	74191 .IEC	74367
7410 .DM	7438	7493	74154 .IEC	74192	74367 .IEC
7410 .IEC	7438 .IEC	7495	74155	74192 .IEC	74368
7412	7439	7496	74155 .IEC	74193	74368 .IEC
7412 .DM	7439 .DM	7497	74156	74193 .IEC	74376
7412 .IEC	7439 .IEC	74100	74156 .IEC	74194	74376 .IEC
7413	7440	74107	74157	74194 .IEC	74390
7413 .DM	7440 .DM	74107 .IEC	74157 .IEC	74195	74390 .IEC
7413 .IEC	7440 .IEC	74109	74159	74195 .IEC	74393
7414	7442	74109 .IEC	74160	74196	74393 .IEC
7414 .DM	7442 .IEC	74111	74160 .IEC	74196 .IEC	74425
7414 .IEC	7445	74111 .IEC	74161	74197	74425 .DM
7416	7445 .IEC	74116	74161 .IEC	74197 .IEC	74490
7416 .DM	7446	74121	74162 .IEC	74198	74490 .IEC



Description

This library contains LS TTL parts from the 74 series. All the parts are packaged for through hole PCB layout and most have corresponding simulator models. De Morgan (negative logic) and IEC versions are provided where appropriate.

Contents

74LS00	74LS19	74LS47 .IEC	74LS114	74LS163 .IEC	74LS243 .IEC
74LS00 .DM	74LS19 .DM	74LS48	74LS114 .IEC	74LS164 .IEC	74LS244
74LS00 .IEC	74LS19 .IEC	74LS48 .IEC	74LS122	74LS165	74LS244 .IEC
74LS01	74LS20	74LS49	74LS122 .IEC	74LS165 .IEC	74LS245
74LS01 .DM	74LS20 .DM	74LS49 .IEC	74LS123	74LS166	74LS245 .IEC
74LS01 .IEC	74LS20 .IEC	74LS51	74LS123 .IEC	74LS166 .IEC	74LS247
74LS02	74LS21	74LS51 .IEC	74LS125	74LS169	74LS248
74LS02 .DM	74LS21 .DM	74LS54	74LS125 .DM	74LS169 .IEC	74LS249
74LS02 .IEC	74LS21 .IEC	74LS55	74LS125 .IEC	74LS170	74LS251
74LS03	74LS22	74LS56	74LS126	74LS171	74LS251 .IEC
74LS03 .IEC	74LS22 .DM	74LS57	74LS126 .DM	74LS173	74LS257
74LS04	74LS22 .IEC	74LS63	74LS126 .IEC	74LS173 .IEC	74LS257 .IEC
74LS04 .DM	74LS24	74LS63 .DM	74LS132	74LS174	74LS258
74LS04 .IEC	74LS24 .DM	74LS68	74LS132 .DM	74LS174 .IEC	74LS258 .IEC
74LS05	74LS24 .IEC	74LS69	74LS132 .IEC	74LS175	74LS259
74LS05 .DM	74LS26	74LS73	74LS136	74LS175 .IEC	74LS259 .IEC
74LS05 .IEC	74LS26 .DM	74LS73 .IEC	74LS136 .IEC	74LS181	74LS266
74LS08	74LS26 .IEC	74LS74	74LS137	74LS181 .IEC	74LS266 .IEC
74LS08 .DM	74LS27	74LS74 .IEC	74LS137 .IEC	74LS183	74LS273
74LS08 .IEC	74LS27 .DM	74LS75	74LS138	74LS190	74LS273 .IEC
74LS09	74LS27 .IEC	74LS75 .IEC	74LS138 .IEC	74LS190 .IEC	74LS279
74LS09 .DM	74LS28	74LS76	74LS139	74LS191	74LS279 .IEC
74LS09 .IEC	74LS28 .DM	74LS76 .IEC	74LS139 .IEC	74LS191 .IEC	74LS280
74LS10	74LS28 .IEC	74LS78	74LS145	74LS192	74LS280 .IEC
74LS10 .DM	74LS30	74LS78 .IEC	74LS147	74LS192 .IEC	74LS283
74LS10 .IEC	74LS30 .DM	74LS83	74LS147 .IEC	74LS193	74LS283 .IEC
74LS11	74LS30 .IEC	74LS85	74LS148	74LS193 .IEC	74LS290
74LS11 .DM	74LS32	74LS85 .IEC	74LS148 .IEC	74LS194	74LS293
74LS11 .IEC	74LS32 .DM	74LS86	74LS153	74LS194 .IEC	74LS295
74LS12	74LS32 .IEC	74LS86 .IEC	74LS153 .IEC	74LS195	74LS298
74LS12 .DM	74LS33	74LS90	74LS155	74LS195 .IEC	74LS298 .IEC
74LS12 .IEC	74LS33 .DM	74LS91	74LS155 .IEC	74LS196	74LS299
74LS13	74LS33 .IEC	74LS92	74LS156	74LS196 .IEC	74LS299 .IEC
74LS13 .DM	74LS37	74LS93	74LS156 .IEC	74LS197	74LS323
74LS13 .IEC	74LS37 .DM	74LS95	74LS157 .IEC	74LS197 .IEC	74LS323 .IEC
74LS14	74LS37 .IEC	74LS96	74LS157 .IEC	74LS221	74LS347
74LS14 .DM	74LS38	74LS107	74LS158	74LS221 .IEC	74LS347 .IEC
74LS14 .IEC	74LS38 .IEC	74LS107 .IEC	74LS158 .IEC	74LS240	74LS352
74LS15	74LS40	74LS109	74LS160	74LS240 .IEC	74LS352 .IEC
74LS15 .DM	74LS40 .DM	74LS109 .IEC	74LS160 .IEC	74LS241	74LS353
74LS15 .IEC	74LS40 .IEC	74LS112	74LS161	74LS241 .IEC	74LS353 .IEC
74LS18	74LS42	74LS112 .IEC	74LS161 .IEC	74LS242	74LS354
74LS18 .DM	74LS42 .IEC	74LS113	74LS162 .IEC	74LS242 .IEC	74LS354 .IEC
74LS18 .IEC	74LS47	74LS113 .IEC	74LS163	74LS243	74LS355

74LS355.IEC	74LS373.IEC	74LS386.IEC	74LS540.IEC	74LS639.IEC	74LS670.IEC
74LS356	74LS374	74LS390	74LS541	74LS640	74LS682
74LS356.IEC	74LS374.IEC	74LS390.IEC	74LS541.IEC	74LS640.IEC	74LS682.IEC
74LS357	74LS375	74LS393	74LS590	74LS641	74LS683
74LS357.IEC	74LS375.IEC	74LS393.IEC	74LS590.IEC	74LS641.IEC	74LS683.IEC
74LS365	74LS377	74LS395	74LS591	74LS642	74LS684
74LS365.IEC	74LS377.IEC	74LS398	74LS591.IEC	74LS642.IEC	74LS684.IEC
74LS366	74LS378	74LS399	74LS592	74LS643	74LS685
74LS366.IEC	74LS379	74LS423	74LS592.IEC	74LS643.IEC	74LS685.IEC
74LS367	74LS381	74LS423.IEC	74LS629	74LS644	
74LS367.IEC	74LS381.IEC	74LS447	74LS629.IEC	74LS644.IEC	
74LS368	74LS382	74LS490	74LS638	74LS645	
74LS368.IEC	74LS382.IEC	74LS490.IEC	74LS638.IEC	74LS645.IEC	
74LS373	74LS386	74LS540	74LS639	74LS670	



Description

This library contains ALS TTL parts from the 74 series. All the parts are packaged for through hole PCB layout, but there are no simulator models. De Morgan (negative logic) and IEC versions are provided where appropriate.

Contents

74ALS00	74ALS15.IEC	74ALS40.DM	74ALS158.IEC	74ALS242.IEC	74ALS540
74ALS00.DM	74ALS20	74ALS40.IEC	74ALS160	74ALS243	74ALS540.IEC
74ALS00.IEC	74ALS20.DM	74ALS74	74ALS160.IEC	74ALS243.IEC	74ALS541
74ALS01	74ALS20.IEC	74ALS74.IEC	74ALS161	74ALS244	74ALS541.IEC
74ALS01.DM	74ALS21	74ALS86	74ALS161.IEC	74ALS244.IEC	74ALS573
74ALS01.IEC	74ALS21.DM	74ALS86.IEC	74ALS162.IEC	74ALS245	74ALS573.IEC
74ALS02	74ALS21.IEC	74ALS109	74ALS163	74ALS245.IEC	74ALS574
74ALS02.DM	74ALS22	74ALS109.IEC	74ALS163.IEC	74ALS257	74ALS574.IEC
74ALS02.IEC	74ALS22.DM	74ALS112	74ALS164.IEC	74ALS257.IEC	74ALS575
74ALS03	74ALS22.IEC	74ALS112.IEC	74ALS165	74ALS258	74ALS576
74ALS03.IEC	74ALS28	74ALS113	74ALS165.IEC	74ALS258.IEC	74ALS577
74ALS04	74ALS28.DM	74ALS113.IEC	74ALS166	74ALS259	74ALS580
74ALS04.DM	74ALS28.IEC	74ALS114	74ALS166.IEC	74ALS259.IEC	74ALS638
74ALS04.IEC	74ALS30	74ALS114.IEC	74ALS168	74ALS273	74ALS638.IEC
74ALS05	74ALS30.DM	74ALS133	74ALS168.IEC	74ALS273.IEC	74ALS639
74ALS05.DM	74ALS30.IEC	74ALS133.DM	74ALS169	74ALS280	74ALS639.IEC
74ALS05.IEC	74ALS32	74ALS133.IEC	74ALS169.IEC	74ALS280.IEC	74ALS640
74ALS08	74ALS32.DM	74ALS136	74ALS174	74ALS299	74ALS640.IEC
74ALS08.DM	74ALS32.IEC	74ALS136.IEC	74ALS174.IEC	74ALS299.IEC	74ALS641
74ALS08.IEC	74ALS33	74ALS137	74ALS175	74ALS323	74ALS641.IEC
74ALS09	74ALS33.DM	74ALS137.IEC	74ALS175.IEC	74ALS323.IEC	74ALS642
74ALS09.DM	74ALS33.IEC	74ALS138	74ALS190	74ALS352	74ALS642.IEC
74ALS09.IEC	74ALS34	74ALS138.IEC	74ALS190.IEC	74ALS352.IEC	74ALS643
74ALS10	74ALS34.DM	74ALS139	74ALS191	74ALS353	74ALS643.IEC
74ALS10.DM	74ALS34.IEC	74ALS139.IEC	74ALS191.IEC	74ALS353.IEC	74ALS644
74ALS10.IEC	74ALS35	74ALS151	74ALS192	74ALS373	74ALS644.IEC
74ALS11	74ALS35.DM	74ALS151.IEC	74ALS192.IEC	74ALS373.IEC	74ALS645
74ALS11.DM	74ALS35.IEC	74ALS153	74ALS193	74ALS374	74ALS645.IEC
74ALS11.IEC	74ALS37	74ALS153.IEC	74ALS193.IEC	74ALS374.IEC	
74ALS12	74ALS37.DM	74ALS156	74ALS240	74ALS518	
74ALS12.DM	74ALS37.IEC	74ALS156.IEC	74ALS240.IEC	74ALS519	
74ALS12.IEC	74ALS38	74ALS157	74ALS241	74ALS520	
74ALS15	74ALS38.IEC	74ALS157.IEC	74ALS241.IEC	74ALS521	
74ALS15.DM	74ALS40	74ALS158	74ALS242	74ALS522	



Description

This library contains Schottky TTL parts from the 74 series. All the parts are packaged for through hole PCB layout and most have corresponding simulator models. De Morgan (negative logic) and IEC versions are provided where appropriate

Contents

74S00	74S11.DM	74S40.IEC	74S134	74S174	74S257
74S00.DM	74S11.IEC	74S51	74S134.DM	74S174.IEC	74S257.IEC
74S00.IEC	74S15	74S51.IEC	74S134.IEC	74S175	74S258
74S02	74S15.DM	74S64	74S135	74S175.IEC	74S258.IEC
74S02.DM	74S15.IEC	74S65	74S139	74S181	74S260
74S02.IEC	74S20	74S74	74S139.IEC	74S181.IEC	74S260.DM
74S03	74S20.DM	74S74.IEC	74S140	74S182	74S280
74S03.IEC	74S20.IEC	74S85	74S140.DM	74S182.IEC	74S280.IEC
74S04	74S22	74S85.IEC	74S140.IEC	74S194	74S283
74S04.DM	74S22.DM	74S86	74S151	74S194.IEC	74S283.IEC
74S04.IEC	74S22.IEC	74S86.IEC	74S151.IEC	74S195	74S299
74S05	74S30	74S112	74S153	74S195.IEC	74S299.IEC
74S05.DM	74S30.DM	74S112.IEC	74S153.IEC	74S196	74S373
74S05.IEC	74S30.IEC	74S113	74S157	74S196.IEC	74S373.IEC
74S08	74S32	74S113.IEC	74S157.IEC	74S197	74S374
74S08.DM	74S32.DM	74S114	74S158	74S197.IEC	74S374.IEC
74S08.IEC	74S32.IEC	74S114.IEC	74S158.IEC	74S240	74S381
74S09	74S37	74S124	74S162.IEC	74S240.IEC	74S381.IEC
74S09.DM	74S37.DM	74S132	74S163	74S241	
74S09.IEC	74S37.IEC	74S132.DM	74S163.IEC	74S241.IEC	
74S10	74S38	74S132.IEC	74S168	74S244	
74S10.DM	74S38.IEC	74S133	74S168.IEC	74S244.IEC	
74S10.IEC	74S40	74S133.DM	74S169	74S251	
74S11	74S40.DM	74S133.IEC	74S169.IEC	74S251.IEC	



Description

This library contains FAST TTL parts from the 74 series. All the parts are packaged for through hole PCB layout but there are no simulator models. De Morgan (negative logic) and IEC versions are provided where appropriate.

Contents

74F00	74F10.DM	74F32.IEC	74F138	74F191	74F283.IEC
74F00.DM	74F10.IEC	74F38	74F138.IEC	74F191.IEC	74F373
74F00.IEC	74F11	74F38.IEC	74F139	74F193	74F373.IEC
74F02	74F11.DM	74F74	74F139.IEC	74F193.IEC	74F374
74F02.DM	74F11.IEC	74F74.IEC	74F153	74F195	74F374.IEC
74F02.IEC	74F14	74F85	74F153.IEC	74F195.IEC	74F377
74F04	74F14.DM	74F85.IEC	74F157	74F240	74F377.IEC
74F04.DM	74F14.IEC	74F86	74F157.IEC	74F240.IEC	74F521
74F04.IEC	74F20	74F86.IEC	74F160	74F244	74F541
74F06	74F20.DM	74F109	74F160.IEC	74F244.IEC	74F541.IEC
74F06.DM	74F20.IEC	74F109.IEC	74F161	74F245	74F543
74F06.IEC	74F27	74F112	74F161.IEC	74F245.IEC	74F573
74F07	74F27.DM	74F112.IEC	74F163	74F257	74F573.IEC
74F07.DM	74F27.IEC	74F125	74F163.IEC	74F257.IEC	74F574
74F07.IEC	74F30	74F125.DM	74F164.IEC	74F260	74F574.IEC
74F08	74F30.DM	74F125.IEC	74F166	74F260.DM	
74F08.DM	74F30.IEC	74F132	74F166.IEC	74F273	
74F08.IEC	74F32	74F132.DM	74F169	74F273.IEC	
74F10	74F32.DM	74F132.IEC	74F169.IEC	74F283	



Description

This library contains high speed CMOS parts from the 74 and 4000 series. All the parts are packaged for through hole PCB layout and most have simulator models. De Morgan (negative logic) and IEC versions are provided where appropriate.

Contents

74HC00	74HC32	74HC137	74HC190	74HC298	74HC574
74HC00.DM	74HC32.DM	74HC137.IEC	74HC190.IEC	74HC298.IEC	74HC574.IEC
74HC00.IEC	74HC32.IEC	74HC138	74HC191	74HC299	74HC590
74HC02	74HC42	74HC138.IEC	74HC191.IEC	74HC299.IEC	74HC590.IEC
74HC02.DM	74HC42.IEC	74HC139	74HC192	74HC323	74HC592
74HC02.IEC	74HC51	74HC139.IEC	74HC192.IEC	74HC323.IEC	74HC592.IEC
74HC03	74HC51.IEC	74HC147	74HC193	74HC352	74HC640
74HC03.IEC	74HC73	74HC147.IEC	74HC193.IEC	74HC352.IEC	74HC640.IEC
74HC04	74HC73.IEC	74HC148	74HC194	74HC353	74HC643
74HC04.DM	74HC74	74HC148.IEC	74HC194.IEC	74HC353.IEC	74HC643.IEC
74HC04.IEC	74HC74.IEC	74HC151	74HC195	74HC354	74HC670
74HC05	74HC75	74HC151.IEC	74HC195.IEC	74HC354.IEC	74HC670.IEC
74HC05.DM	74HC75.IEC	74HC153	74HC221	74HC356	74HC4002
74HC05.IEC	74HC76	74HC153.IEC	74HC221.IEC	74HC356.IEC	74HC4002.DM
74HC07	74HC76.IEC	74HC154	74HC238	74HC365	74HC4002.IEC
74HC07.DM	74HC77	74HC154.IEC	74HC238.IEC	74HC365.IEC	74HC4016
74HC07.IEC	74HC77.IEC	74HC155	74HC240	74HC366	74HC4016.IEC
74HC08	74HC85	74HC155.IEC	74HC240.IEC	74HC366.IEC	74HC4017
74HC08.DM	74HC85.IEC	74HC157	74HC241	74HC367	74HC4017.IEC
74HC08.IEC	74HC86	74HC157.IEC	74HC241.IEC	74HC367.IEC	74HC4020
74HC09	74HC86.IEC	74HC158	74HC243	74HC368	74HC4020.IEC
74HC09.DM	74HC93	74HC158.IEC	74HC243.IEC	74HC368.IEC	74HC4022
74HC09.IEC	74HC107	74HC160	74HC244	74HC373	74HC4022.IEC
74HC10	74HC107.IEC	74HC160.IEC	74HC244.IEC	74HC373.IEC	74HC4024
74HC10.DM	74HC109	74HC161	74HC245	74HC374	74HC4024.IEC
74HC10.IEC	74HC109.IEC	74HC161.IEC	74HC245.IEC	74HC374.IEC	74HC4028
74HC11	74HC112	74HC162.IEC	74HC251	74HC375	74HC4028.IEC
74HC11.DM	74HC112.IEC	74HC163	74HC251.IEC	74HC375.IEC	74HC4040
74HC11.IEC	74HC113	74HC163.IEC	74HC257	74HC377	74HC4040.IEC
74HC14	74HC113.IEC	74HC164.IEC	74HC257.IEC	74HC377.IEC	74HC4046
74HC14.DM	74HC123	74HC165	74HC258	74HC386	74HC4046.IEC
74HC14.IEC	74HC123.IEC	74HC165.IEC	74HC258.IEC	74HC386.IEC	74HC4049
74HC20	74HC125	74HC166	74HC259	74HC390	74HC4049.DM
74HC20.DM	74HC125.DM	74HC166.IEC	74HC259.IEC	74HC390.IEC	74HC4049.IEC
74HC20.IEC	74HC125.IEC	74HC173	74HC266	74HC393	74HC4050
74HC21	74HC126	74HC173.IEC	74HC266.IEC	74HC393.IEC	74HC4050.DM
74HC21.DM	74HC126.DM	74HC174	74HC273	74HC423	74HC4050.IEC
74HC21.IEC	74HC126.IEC	74HC174.IEC	74HC273.IEC	74HC423.IEC	74HC4051
74HC27	74HC132	74HC175	74HC279	74HC540	74HC4051.IEC
74HC27.DM	74HC132.DM	74HC175.IEC	74HC279.IEC	74HC540.IEC	74HC4052
74HC27.IEC	74HC132.IEC	74HC181	74HC280	74HC541	74HC4052.IEC
74HC30	74HC133	74HC181.IEC	74HC280.IEC	74HC541.IEC	74HC4053
74HC30.DM	74HC133.DM	74HC182	74HC283	74HC573	74HC4053.IEC
74HC30.IEC	74HC133.IEC	74HC182.IEC	74HC283.IEC	74HC573.IEC	74HC4060

74HC4060.IEC	74HC4072.DM	74HC4078.DM	74HC4514	74HC4520	74HC40102
74HC4066	74HC4072.IEC	74HC4078.IEC	74HC4514.IEC	74HC4520.IEC	74HC40103
74HC4066.IEC	74HC4075	74HC4094	74HC4515	74HC4538	74HC40105
74HC4067	74HC4075.DM	74HC4094.IEC	74HC4515.IEC	74HC4538.IEC	
74HC4067.IEC	74HC4075.IEC	74HC4511	74HC4518	74HC4543	
74HC4072	74HC4078	74HC4511.IEC	74HC4518.IEC	74HC4543.IEC	



Description

This library contains high speed CMOS (TTL compatible) parts from the 74 and 4000 series. All the parts are packaged for through hole PCB layout and most have simulator models. De Morgan (negative logic) and IEC versions are provided where appropriate.

Contents

74HCT00	74HCT73 .IEC	74HCT157	74HCT258	74HCT4002 .DM
74HCT00 .DM	74HCT74	74HCT157 .IEC	74HCT258 .IEC	74HCT4002 .IEC
74HCT00 .IEC	74HCT74 .IEC	74HCT158	74HCT259	74HCT4016
74HCT02	74HCT75	74HCT158 .IEC	74HCT259 .IEC	74HCT4016 .IEC
74HCT02 .DM	74HCT75 .IEC	74HCT160	74HCT273	74HCT4017
74HCT02 .IEC	74HCT85	74HCT160 .IEC	74HCT273 .IEC	74HCT4017 .IEC
74HCT03	74HCT85 .IEC	74HCT161	74HCT283	74HCT4020
74HCT03 .IEC	74HCT86	74HCT161 .IEC	74HCT283 .IEC	74HCT4020 .IEC
74HCT04	74HCT86 .IEC	74HCT163	74HCT299	74HCT4024
74HCT04 .DM	74HCT93	74HCT163 .IEC	74HCT299 .IEC	74HCT4024 .IEC
74HCT04 .IEC	74HCT107	74HCT164 .IEC	74HCT365	74HCT4040
74HCT08	74HCT107 .IEC	74HCT165	74HCT365 .IEC	74HCT4040 .IEC
74HCT08 .DM	74HCT109	74HCT165 .IEC	74HCT367	74HCT4046
74HCT08 .IEC	74HCT109 .IEC	74HCT166	74HCT367 .IEC	74HCT4046 .IEC
74HCT10	74HCT112	74HCT166 .IEC	74HCT373	74HCT4051
74HCT10 .DM	74HCT112 .IEC	74HCT173	74HCT373 .IEC	74HCT4051 .IEC
74HCT10 .IEC	74HCT123	74HCT173 .IEC	74HCT374	74HCT4052
74HCT11	74HCT123 .IEC	74HCT174	74HCT374 .IEC	74HCT4052 .IEC
74HCT11 .DM	74HCT125	74HCT174 .IEC	74HCT377	74HCT4053
74HCT11 .IEC	74HCT125 .DM	74HCT175	74HCT377 .IEC	74HCT4053 .IEC
74HCT14	74HCT125 .IEC	74HCT175 .IEC	74HCT390	74HCT4059
74HCT14 .DM	74HCT126	74HCT190	74HCT390 .IEC	74HCT4059 .IEC
74HCT14 .IEC	74HCT126 .DM	74HCT190 .IEC	74HCT393	74HCT4060
74HCT20	74HCT126 .IEC	74HCT191	74HCT393 .IEC	74HCT4060 .IEC
74HCT20 .DM	74HCT132	74HCT191 .IEC	74HCT423	74HCT4066
74HCT20 .IEC	74HCT132 .DM	74HCT193	74HCT423 .IEC	74HCT4066 .IEC
74HCT21	74HCT132 .IEC	74HCT193 .IEC	74HCT540	74HCT4075
74HCT21 .DM	74HCT137	74HCT221	74HCT540 .IEC	74HCT4075 .DM
74HCT21 .IEC	74HCT137 .IEC	74HCT221 .IEC	74HCT541	74HCT4075 .IEC
74HCT27	74HCT138	74HCT238	74HCT541 .IEC	74HCT4094
74HCT27 .DM	74HCT138 .IEC	74HCT238 .IEC	74HCT573	74HCT4094 .IEC
74HCT27 .IEC	74HCT139	74HCT240	74HCT573 .IEC	74HCT4511
74HCT30	74HCT139 .IEC	74HCT240 .IEC	74HCT574	74HCT4511 .IEC
74HCT30 .DM	74HCT147	74HCT241	74HCT574 .IEC	74HCT4514
74HCT30 .IEC	74HCT147 .IEC	74HCT241 .IEC	74HCT640	74HCT4514 .IEC
74HCT32	74HCT151	74HCT244	74HCT640 .IEC	74HCT4520
74HCT32 .DM	74HCT151 .IEC	74HCT244 .IEC	74HCT643	74HCT4520 .IEC
74HCT32 .IEC	74HCT153	74HCT245	74HCT643 .IEC	74HCT4538
74HCT42	74HCT153 .IEC	74HCT245 .IEC	74HCT670	74HCT4538 .IEC
74HCT42 .IEC	74HCT154	74HCT257	74HCT670 .IEC	74HCT40103
74HCT73	74HCT154 .IEC	74HCT257 .IEC	74HCT4002	74HCT40105



Description

This library contains miscellaneous but commonly used analog devices including regulators, amplifiers and data acquisition ICs. The data was taken from a number of sources. All the parts are packaged for PCB layout and a few have simulator models.

Contents

78L05	79L12	7815	DAC0801	LM837	ZN427
78L08	79L15	7824	DAC0802	LM1877	ZN428
78L12	79L24	7905	DG507	LMC835	ZN448
78L15	555	7908	HI-507	M145026	
78L24	7555	7912	LM317L	M145027	
78S40	7805	7915	LM337L	NE555	
79L05	7808	7924	LM380	NE565	
79L08	7812	DAC0800	LM833N	ZN426	



Description

This library contains CMOS parts from the 4000 series. All the parts are packaged for through hole PCB layout and most have simulator models. De Morgan (negative logic) and IEC versions are provided where appropriate.

Contents

4000	4020 .IEC	4046 .IEC	4071 .DM	4508 .IEC	4555 .IEC
4000 .IEC	4021	4047	4071 .IEC	4510	4556
4001	4021 .IEC	4047 .IEC	4072	4510 .IEC	4556 .IEC
4001 .DM	4022	4048	4072 .DM	4511	4559
4001 .IEC	4022 .IEC	4049	4072 .IEC	4511 .IEC	4560
4002	4023	4049 .DM	4073	4512	4584
4002 .DM	4023 .DM	4049 .IEC	4073 .DM	4512 .IEC	4584 .DM
4002 .IEC	4023 .IEC	4050	4073 .IEC	4513	4585
4006	4024	4050 .DM	4075	4514	4585 .IEC
4006 .IEC	4024 .IEC	4050 .IEC	4075 .DM	4514 .IEC	40102
4007	4025	4051	4075 .IEC	4515	40103
4008	4025 .DM	4051 .IEC	4076	4515 .IEC	40104
4008 .IEC	4025 .IEC	4052	4076 .IEC	4516	40105
4009	4026	4052 .IEC	4077	4516 .IEC	40106
4009 .DM	4027	4053	4077 .DM	4518	40106 .DM
4010	4027 .IEC	4053 .IEC	4077 .IEC	4518 .IEC	40106 .IEC
4010 .DM	4028	4054	4078	4520	40160
4011	4028 .IEC	4055	4078 .DM	4520 .IEC	40160 .IEC
4011 .DM	4029	4056	4078 .IEC	4522	40161
4011 .IEC	4029 .IEC	4059	4081	4522 .IEC	40161 .IEC
4012	4030	4059 .IEC	4081 .DM	4526	40162
4012 .DM	4030 .DM	4060	4081 .IEC	4526 .IEC	40162 .IEC
4012 .IEC	4030 .IEC	4060 .IEC	4082	4528	40163
4013	4033	4063	4082 .DM	4528 .IEC	40163 .IEC
4013 .IEC	4034	4066	4082 .IEC	4529	40174
4014	4035	4066 .IEC	4085	4530	40174 .IEC
4014 .IEC	4035 .IEC	4067	4085 .IEC	4532	40175
4015	4040	4067 .IEC	4089	4532 .IEC	40175 .IEC
4015 .IEC	4040 .IEC	4068	4094	4537	40192
4016	4041	4068 .DM	4094 .IEC	4538	40192 .IEC
4016 .IEC	4041 .DM	4068 .IEC	4095	4538 .IEC	40193
4017	4041 .IEC	4069	4096	4539	40193 .IEC
4017 .IEC	4042	4069 .DM	4098	4539 .IEC	40194
4018	4042 .IEC	4069 .IEC	4099	4541	40194 .IEC
4018 .IEC	4043	4070	4502	4541 .IEC	
4019	4043 .IEC	4070 .DM	4502 .IEC	4543	
4019 .IEC	4044	4070 .IEC	4503	4543 .IEC	
4020	4046	4071	4508	4555	



Description

This library contains parts from the ECL 10000 series. The parts are packaged for through hole PCB layout but there are no simulator models.

Contents

10113	10130	10137	10159	10166	10178
10115	10131	10138	10161	10173	10181
10116	10133	10141	10162	10174	10186A
10124	10135	10145	10164	10175	
10125	10136	10158	10165	10176	



Description

This library contains commonly used memory ICs from a number of manufacturers. All the parts are packaged for through hole PCB design but there are no simulator models.

Contents

27C64	2149	4016	5513	6665	27512
27C128	2164	4164	5514	8128	27513
27C256	2600	4256	5516	8264	41256
2015	2620	4257	5517	8266	48416
2016	2716	4264	5564	8281	50256
2018	2732	4416	5565	8416	50257
2019	2764	4564	6116	8417	57256
2063	2816	4864	6164	8418	58064
2064	2817	5113	6256	8464	62256
2114	2864	5164	6257	27128	
2148	3764	5165	6264	27256	



Description

This library contains commonly used microprocessor ICs from a number of manufacturers. All the parts are packaged for PCB design but there are no simulator models.

Some of the parts are provided in both separately pinned and bus pinned versions.

Contents

68HC11A8	83C51FB	87C654	68010.BUS	PIC16C57
68HC11D3	83C51FC	8031	AT-BUS	PIC16C57.BUS
68HC24	83C055	8031.BUS	AY-3-1015	PIC16C71
68HC811E2	83C504	8032	ICM7170	PIC16C71.BUS
80C31	83C508	8032.BUS	MCS8051	PIC16F83
80C32	83C576	8039	MCS8052	PIC16F84
80C51	83C654	8039.BUS	NM232CD	XA-G3
80C51FA	83C748	8049	P8XC592	Z80
80C52	83C749	8049.BUS	P8XCE598	Z80 CPU
80C54	83C750	8051	P83C524	Z80 CTC
80C58	83C751	8051.BUS	P83CE558	Z80 DART
80C451	83C752	8052	P83CE559	Z80 DMA
80C453	83CL781	8052.BUS	PC-BUS	Z80 PIO
80C528	83L51FA	8255A	PIC16C54	
80C550	83L51FB	68000	PIC16C54.BUS	
80C575	87C524	68000.BUS	PIC16C55	
80C652	87C528	68008	PIC16C55.BUS	
80CL31	87C552	68008.BUS	PIC16C56	
80CL410	87C652	68010	PIC16C56.BUS	



Description

This library contains Operational Amplifiers from a number of manufacturers. All the parts are packaged for through hole PCB layout and are linked to appropriate simulator macro models.

Contents

709	CA3130	LF355	LM6364	OP-77GP	TL062
741	CA3140	LF411	LT1013CN8	OP-90GP	TL064
747	CA3160	LF412CN	LT1014CN	OP-200GP	TL071
748	CA3240	LF441	LT1028	OP09	TL072
1458	CA3260	LF442	LT1077CN8	OP11	TL074
1558	CA5130	LF444	MC3403	OP14	TL075
3403	CA5160	LF13741	MC33078	OP215	TL081
4136	CA5260	LM124	MC33171P	OP220	TL082
4156	EL2020	LM224	MC33172P	OP221	TL084
4227G	EL2030CN	LM301	MC33174P	OP400	TL085
4559	EL2120CN	LM308	NE531	OPA121KP	TLC272
AD642	EL2232	LM324	NE5532	OPA404KP	TLC274
AD644	LF137	LM348	NE5534	OPA606KP	TLE2027C
AD647	LF147	LM358N	OP-07CN	OPA2107AP	TLE2037C
AD648JN	LF347	LM392	OP-27G	OPA2111KP	UA709
AD711JN	LF351	LM833N	OP-37GN	PM-1008GP	UA741
AD712JN	LF353N	LM837	OP-47G	TL061	UA747C

Notes

This library was created for PROTEUS 3.0 and many of the devices in it are now also available from the manufacturer specific libraries – NATOA, TEXOAC and LINTEC. The manufacturer specific libraries may have more accurate (manufacturer designed) SPICE models, whereas the parts in this library are modeled using generic macro model files.



Description

This library contains Programmable Logic Devices. The parts are packaged for through hole PCB design and contain appropriate property definitions for simulation.

The packaging and timing data was obtained from the relevant AMD data-book.

Contents

AM16L8	AM16R6	AM16V8	AM20R8	AM20V8	AM29M16
AM16R4	AM16R8	AM20R4	AM20RA10	AM22V10	AM29MA16



Description

This library contains discrete components from Fairchild Semiconductor Inc. All the parts are packaged for PCB layout and are linked to the manufacturer's SPICE models in FAIRCHLD.SML.

Contents

2N2608	2N3972	2N4857A	2N5452	J404	PN3565
2N2609	2N4084	2N4858	2N5454	J405	PN3638
2N3370	2N4091	2N4858A	2N5515	J406	PN3638A
2N3390	2N4092	2N4859	2N5516	J410	PN3640
2N3391A	2N4093	2N4859A	2N5517	J411	PN3642
2N3392	2N4117	2N4860	2N5518	J412	PN3643
2N3393	2N4117A	2N4860A	2N5519	MPS3702	PN3644
2N3415	2N4118	2N4861	2N5520	MPS3703	PN3645
2N3416	2N4118A	2N4861A	2N5521	MPS6513	PN3646
2N3417	2N4119	2N5018	2N5522	MPS6514	PN4121
2N3458	2N4119A	2N5019	2N5523	MPS6515	PN4122
2N3459	2N4123	2N5020	2N5524	MPS6518	PN4141
2N3684	2N4124	2N5021	2N5545	MPS6521	PN4143
2N3685	2N4125	2N5045	2N5550	MPS6523	PN4249
2N3686	2N4126	2N5046	2N5551	MPS6531	PN4250
2N3687	2N4220	2N5047	2N5556	MPS6534	PN4250A
2N3702	2N4220A	2N5078	2N5557	MPS6562	PN4258
2N3703	2N4221	2N5086	2N5558	MPS8098	PN4275
2N3821	2N4221A	2N5087	2N5565	MPSA05	PN4355
2N3822	2N4222	2N5088	2N5566	MPSA06	PN4356
2N3823	2N4222A	2N5089	2N5769	MPSA10	PN4917
2N3824	2N4223	2N5103	2N5771	MPSA18	PN5134
2N3859A	2N4338	2N5105	2N5772	MPSA20	PN5138
2N3903	2N4339	2N5114	2N5830	MPSA42	ST5771-1
2N3904	2N4340	2N5115	2N5902	MPSA43	TIS93
2N3905	2N4341	2N5116	2N5904	MPSA55	TIS97
2N3906	2N4381	2N5172	2N5905	MPSA56	TIS98
2N3921	2N4391	2N5196	2N5906	MPSA92	TN2219A
2N3922	2N4392	2N5197	2N5907	MPSA93	TN2905A
2N3954	2N4393	2N5199	2N5909	MPSH10	U308
2N3954A	2N4400	2N5210	2N5911	MPSL01	U309
2N3955	2N4401	2N5358	2N5912	MPSL51	U310
2N3955A	2N4402	2N5366	2N6483	PN930	U401
2N3956	2N4403	2N5397	2N6484	PN2222	U402
2N3957	2N4410	2N5398	2N6485	PN2222A	U403
2N3958	2N4416	2N5400	BC548C	PN2369	U404
2N3966	2N4416A	2N5401	J201	PN2369A	U405
2N3967	2N4856	2N5432	J401	PN2484	U406
2N3970	2N4856A	2N5433	J402	PN2907	U440
2N3971	2N4857	2N5434	J403	PN2907A	U441



Description

This library contains operational amplifiers from Linear Technology Inc. All the parts are packaged for PCB design and are linked to the manufacturer's SPICE models in LINTEC.SML.

Contents

LF155	LT1001A	LT1055S8	LT1194	LT1229	LTC1052
LF155A	LT1006	LT1056	LT1195	LT1230	LTC1053
LF156	LT1006A	LT1056A	LT1200	LT1251	OP05
LF156A	LT1006S8	LT1056S8	LT1201	LT1252	OP05A
LF355	LT1007	LT1057	LT1202	LT1253	OP05C
LF355A	LT1007A	LT1057A	LT1206	LT1254	OP05E
LF356	LT1008	LT1058	LT1208	LT1256	OP07
LF356A	LT1012A	LT1058A	LT1209	LT1354	OP07A
LF412	LT1012D	LT1078	LT1211	LT1355	OP07C
LF412A	LT1012S8	LT1078A	LT1212	LT1356	OP07E
LM10C	LT1013	LT1079	LT1213	LT1357	OP15A
LM101A	LT1013A	LT1079A	LT1214	LT1358	OP15B
LM107	LT1013D	LT1097	LT1215	LT1359	OP15C
LM108	LT1014	LT1101	LT1216	LT1360	OP16A
LM108A	LT1014A	LT1115	LT1217	LT1361	OP16B
LM118	LT1014AD	LT1122	LT1220	LT1362	OP16C
LM301A	LT1022	LT1178	LT1221	LT1363	OP27A
LM307	LT1022A	LT1179	LT1222	LT1364	OP27C
LM308	LT1028	LT1187	LT1223	LT1365	OP37A
LM308A	LT1028A	LT1189	LT1224	LTC1047	OP37C
LM318	LT1037	LT1190	LT1225	LTC1049	OP215A
LT118A	LT1037A	LT1191	LT1226	LTC1050	OP215C
LT318A	LT1055	LT1192	LT1227	LTC1050A	
LT1001	LT1055A	LT1193	LT1228	LTC1051	



Description

This library contains data acquisition devices from National Semiconductor Inc. The parts are packaged for PCB layout but there are no simulator models.

Contents

ADC12L030	ADC1061	ADC10731	DAC0831	LM113	LM368-5V0
ADC12L032	ADC1205	ADC10732	DAC0832	LM129	LM368-10V
ADC12L034	ADC1225	ADC10734	DAC0854	LM131	LM369
ADC12L038	ADC1241	ADC10738	DAC0890	LM134	LM385
ADC080X	ADC1242	ADC10831	DAC1006	LM135	LM385-1V2
ADC0808	ADC1251	ADC10832	DAC1007	LM136-2V5	LM385-2V5
ADC0809	ADC08031	ADC10834	DAC1008	LM136-5V0	LM399
ADC0811	ADC08032	ADC10838	DAC1054	LM169	LM3999
ADC0816	ADC08034	ADC12030	DAC1208	LM185	LM4040
ADC0817	ADC08038	ADC12032	DAC1209	LM185-1V2	LM4041
ADC0819	ADC08061	ADC12034	DAC1210	LM185-2V5	LM4431
ADC0820	ADC08062	ADC12038	DAC1218	LM199	LM9140
ADC0831	ADC08131	ADC12062	DAC1219	LM231	LM12434
ADC0832	ADC08134	ADC12130	DAC1230	LM234	LM12458
ADC0833	ADC08138	ADC12132	DAC1231	LM235	LMF40
ADC0834	ADC08161	ADC12138	DAC1232	LM236-2V5	LMF60
ADC0838	ADC08231	ADC12441	LF198	LM236-5V0	LMF90
ADC0841	ADC08234	ADC12662	LF298	LM285	LMF100
ADC0844	ADC08238	ADC16071	LF398	LM285-1V2	LMF380
ADC0848	ADC10061	ADC16471	LF13006	LM285-2V5	MF4
ADC0851	ADC10062	DAC102X	LF13007	LM299	MF5
ADC0852	ADC10064	DAC122X	LH0070	LM313	MF6
ADC0854	ADC10154	DAC0800	LH0071	LM329	MF8
ADC0858	ADC10158	DAC0801	LM12L454	LM331	MF10
ADC1001	ADC10461	DAC0802	LM12L458	LM334	
ADC1005	ADC10462	DAC0806	LM34	LM335	
ADC1031	ADC10464	DAC0807	LM35	LM336-2V5	
ADC1034	ADC10662	DAC0808	LM45	LM336-5V0	
ADC1038	ADC10664	DAC0830	LM50	LM368-2V5	



Description

This library contains operational amplifiers from National Semiconductor. All the parts are packaged for PCB layout and most are linked to the manufacturer's SPICE models in NATOA.SML.

Contents

LF155	LM258	LM6181	LMC6001A	LMC6082B	LMC6681A
LF156	LM318	LM6218	LMC6001B	LMC6084A	LMC6681B
LF157	LM324	LM6261	LMC6022	LMC6084B	LMC6762A
LF351	LM358	LM6262	LMC6024	LMC6462A	LMC6762B
LF353	LM741	LM6264	LMC6032	LMC6462B	LMC6772A
LF411	LM2902	LM6265	LMC6034	LMC6464A	LMC6772B
LF412	LM2904	LM6361	LMC6041A	LMC6464B	LMC7101A
LF441A	LM6118	LM6362	LMC6041B	LMC6482A	LMC7101B
LF441B	LM6121	LM6364	LMC6042A	LMC6484A	LMC7111A
LF442A	LM6132A	LM6365	LMC6042B	LMC6492A	LMC7111B
LF442B	LM6132B	LM7121	LMC6044A	LMC6492B	LMC7211A
LF444A	LM6142A	LM7131A	LMC6044B	LMC6494A	LMC7211B
LF444B	LM6142B	LM7131B	LMC6061A	LMC6494B	LMC7221A
LF451	LM6152A	LM7171A	LMC6061B	LMC6572A	LMC7221B
LF453	LM6152B	LM7171B	LMC6062A	LMC6572B	LPC660A
LM111	LM6161	LM13600	LMC6062B	LMC6574A	LPC660B
LM118	LM6162	LM13700	LMC6064A	LMC6574B	LPC661A
LM124	LM6164	LMC660A	LMC6064B	LMC6582A	LPC661B
LM158	LM6165	LMC660B	LMC6081A	LMC6582B	LPC662A
LM218	LM6171A	LMC662A	LMC6081B	LMC6584A	LPC662B
LM224	LM6171B	LMC662B	LMC6082A	LMC6584B	



Description

This library contains SCRs and TRIACs from Teccor inc. All the parts are packaged for PCB design and are linked to the manufacturer's SPICE models in TECCOR.SML.

Contents

2N5063	L401E6	Q2025R5	S0506FS31	S1010LS2	S4003FS11
2N5064	L401E8	Q4004L3	S0506L	S1010LS3	S4003FS21
2N6564	L601E3	Q4004L4	S0506LS2	S1010R	S4003FS31
2N6565	L601E5	Q4006L4	S0506LS3	S1012R	S4003LS1
EC103A	L601E6	Q4008L4	S0508FS21	S1015L	S4003LS2
EC103A1	L601E8	Q4010L5	S0508FS31	S1016R	S4003LS3
EC103A2	L2002L8	Q4015L5	S0508L	S1020L	S4004F1
EC103A3	L2004L3	Q4025R5	S0508LS2	S1025L	S4006FS21
EC103B	L2004L5	Q5004L3	S0508LS3	S1035J	S4006FS31
EC103B1	L2004L6	Q5004L4	S0510FS21	S1040R	S4006L
EC103B2	L2004L8	Q5006L4	S0510FS31	S1055R	S4006LS2
EC103B3	L2006L5	Q5008L4	S0510L	S1065J	S4006LS3
EC103C	L2006L6	Q5010L5	S0510LS2	S1070W	S4008FS21
EC103C1	L2006L8	Q5015L5	S0510LS3	S2003FS11	S4008FS31
EC103C2	L2008L6	Q5025R5	S0510R	S2003FS21	S4008L
EC103C3	L4004L3	Q6004L3	S0512R	S2003FS31	S4008LS2
EC103D	L4004L5	Q6004L4	S0515L	S2003LS1	S4008LS3
EC103D1	L4004L6	Q6006L5	S0516R	S2003LS2	S4010FS21
EC103D2	L4004L8	Q6008L5	S0520L	S2003LS3	S4010FS31
EC103D3	L4006L5	Q6010L5	S0525L	S2004F1	S4010L
EC103E	L4006L6	Q6015L5	S0535J	S2006FS21	S4010LS2
EC103E1	L4006L8	Q6025R5	S0540R	S2006FS31	S4010LS3
EC103E2	L4008L6	Q7004L4	S0555R	S2006L	S4010R
EC103E3	L4008L8	Q7006L5	S0565J	S2006LS2	S4012R
EC103M	L6004L3	Q7008L5	S0570W	S2006LS3	S4015L
EC103M1	L6004L5	Q7010L5	S601E	S2008FS21	S4016R
EC103M2	L6004L6	Q7015L5	S1003FS11	S2008FS31	S4020L
EC103M3	L6004L8	Q7025R5	S1003FS21	S2008L	S4025L
EC113A	L6006L5	Q8004L4	S1003FS31	S2008LS2	S4035J
EC113A3	L6006L6	Q8006L5	S1003LS1	S2008LS3	S4040R
EC113B	L6006L8	Q8008L5	S1003LS2	S2010FS21	S4055R
EC113B3	L6008L6	Q8010L5	S1003LS3	S2010FS31	S4065J
EC113C	Q201E3	Q8015L5	S1004F1	S2010L	S4070W
EC113C3	Q201E4	Q8025R5	S1006FS21	S2010LS2	S6003FS11
EC113D	Q401E3	S051E	S1006FS31	S2010LS3	S6003FS21
EC113D3	Q401E4	S101E	S1006L	S2010R	S6003FS31
EC113E	Q501E3	S201E	S1006LS2	S2012R	S6003LS1
EC113E3	Q501E4	S401E	S1006LS3	S2015L	S6003LS2
EC113M	Q601E3	S0503FS11	S1008FS21	S2016R	S6003LS3
EC113M3	Q601E4	S0503FS21	S1008FS31	S2020L	S6004F1
L201E3	Q2004L3	S0503FS31	S1008L	S2025L	S6006FS21
L201E5	Q2004L4	S0503LS1	S1008LS2	S2035J	S6006FS31
L201E6	Q2006L4	S0503LS2	S1008LS3	S2040R	S6006L
L201E8	Q2008L4	S0503LS3	S1010FS21	S2055R	S6006LS2
L401E3	Q2010L5	S0504F1	S1010FS31	S2065J	S6006LS3
L401E5	Q2015L5	S0506FS21	S1010L	S2070W	S6008FS21

S6008FS31	S6010R	S6065J	S8020L	T106C1	T107E1
S6008L	S6012R	S6070W	S8025L	T106D1	T107F1
S6008LS2	S6015L	S8006L	S8035J	T106E1	T107M1
S6008LS3	S6016R	S8008L	S8040R	T106F1	TCR222
S6010FS21	S6020L	S8010L	S8055R	T106M1	TCR223
S6010FS31	S6025L	S8010R	S8065J	T107A1	TCR224
S6010L	S6035J	S8012R	S8070W	T107B1	TCR226
S6010LS2	S6040R	S8015L	T106A1	T107C1	TCR228
S6010LS3	S6055R	S8016R	T106B1	T107D1	



Description

This library contains operational amplifiers and comparators from Texas Instruments. All the parts are packaged for PCB design and where the models are available, are linked to the manufacturer's SPICE models in the files TEX101.SML, TEX301.SML, TEX401.SML, TEX3_1.SML and TEX5_1.SML.

Contents

A741	LM2902	TL054	TLC251	TLC2274	TLE2682
LF347	LM2903	TL061	TLC251H	TLC2652	TLV1393
LF351	LM2904	TL062	TLC251L	TLC2654	TLV2252
LF353	LM3302	TL064	TLC251M	TLC2801	TLV2254
LF411	LM3900	TL064X2	TLC252	TLC2810	TLV2262
LF412	LP111	TL070	TLC252C	TLC2872	TLV2264
LM111	LP211	TL071	TLC254	TLC3702	TLV2322
LM118	LP239	TL072	TLC254C	TLC3704	TLV2322I
LM124	LP311	TL074	TLC271	TLE2021	TLV2324
LM139	LP339	TL074X2	TLC271H	TLE2022	TLV2324I
LM148	LP2901	TL081	TLC271M	TLE2024	TLV2332
LM158	LT1013	TL082	TLC272	TLE2027	TLV2332I
LM193	MC1458	TL084	TLC274	TLE2037	TLV2334
LM211	MC1558	TL084X2	TLC274X2	TLE2061	TLV2334I
LM218	MC3303	TL393	TLC277	TLE2062	TLV2341
LM224	MC3403	TL712	TLC279	TLE2064	TLV2341H
LM239	NE5532	TL714	TLC339	TLE2071	TLV2341L
LM248	NE5534	TL2828	TLC352	TLE2072	TLV2341M
LM258	OP07	TL2829	TLC354	TLE2074	TLV2342
LM293	RC4136	TLC25L2	TLC371	TLE2081	TLV2342I
LM306	RC4558	TLC25L2C	TLC372	TLE2082	TLV2344
LM311	RM4136	TLC25L4	TLC374	TLE2084	TLV2344I
LM318	RM4558	TLC25L4C	TLC393	TLE2141	TLV2352
LM324	RV4136	TLC25M2	TLC1078	TLE2142	TLV2352I
LM324X2	RV4558	TLC25M2C	TLC1079	TLE2144	TLV2354
LM339	SE5534	TLC25M4	TLC2201	TLE2161	TLV2354I
LM339X2	TL022	TLC25M4C	TLC2202	TLE2227	TLV2362
LM348	TL031	TLC27L2	TLC2252	TLE2237	TLV2393
LM358	TL032	TLC27L4	TLC2254	TLE2301	
LM393	TL034	TLC27M2	TLC2262	TLE2425	
LM2900	TL051	TLC27M4	TLC2264	TLE2426	
LM2901	TL052	TLC139	TLC2272	TLE2662	



Description

This library contains discrete components from Zetex PLC. All the parts are packaged for PCB design and are linked to the manufacturer's SPICE models in ZETEX.SML.

Contents

2N2222A	BC549BP	FMMD2836	FZT649	ZDX2F	ZTX688B
2N6715	BC550BP	FMMD2837	FZT651	ZDX5	ZTX689B
2N6727	BC556AP	FMMD2838	FZT657	ZDX6	ZTX690B
BAL74	BC557AP	FMMD6050	FZT658	ZTX107	ZTX692B
BAL99	BC558AP	FMMD6100	FZT688B	ZTX107B	ZTX694B
BAR74	BC559AP	FMMD7000	FZT689B	ZTX108	ZTX696B
BAR99	BC560AP	FMMT489	FZT690B	ZTX108B	ZTX749
BAS16	BC807-16	FMMT491A	FZT692B	ZTX109	ZTX750
BAS19	BC808-16	FMMT549	FZT694B	ZTX109B	ZTX751
BAS20	BC846B	FMMT589	FZT696B	ZTX212	ZTX753
BAS21	BC847B	FMMT591A	FZT749	ZTX212A	ZTX757
BAV70	BC848B	FMMT597	FZT751	ZTX213	ZTX758
BAV74	BC849B	FMMT617	FZT757	ZTX213A	ZTX788A
BAV99	BC850B	FMMT618	FZT758	ZTX214	ZTX788B
BAW56	BC856A	FMMT619	FZT788B	ZTX214A	ZTX789A
BBY31	BC857A	FMMT624	FZT789A	ZTX237	ZTX790A
BBY40	BC858A	FMMT625	FZT790A	ZTX237B	ZTX792A
BC107BP	BC859A	FMMT717	FZT792A	ZTX238	ZTX795A
BC108BP	BC860A	FMMT718	HD2A	ZTX238B	ZTX796A
BC109BP	BCV72	FMMT720	HD3A	ZTX239	ZTX849
BC177AP	BCW29	FMMT722	HD4A	ZTX239B	ZTX851
BC178AP	BCW32	FMMT723	MPS5179	ZTX320	ZTX869
BC182BP	BCW60C	FMMT918	MPSA20	ZTX321	ZTX948
BC183BP	BCW61A	FMMT5179	MPSH10	ZTX325	ZTX949
BC212AP	BCW65A	FMMTA20	ZC820A	ZTX327	ZTX951
BC237BP	BCW66F	FMMTA70	ZC821A	ZTX360	ZTX953
BC238BP	BCW67A	FMMTH10	ZC822A	ZTX450	ZTX955
BC239BP	BCW68F	FMMV105G	ZC823A	ZTX454	ZTX956
BC307AP	BCW69	FMMV109	ZC824A	ZTX455	ZTX957
BC308AP	BCW72	FMMV2101	ZC825A	ZTX458	ZTX958
BC337AP	BCW89	FMMV2102	ZC826A	ZTX549	ZTX968
BC338AP	BCX70J	FMMV2103	ZC830A	ZTX550	ZTX1047A
BC413BP	BCX71G	FMMV2104	ZC831A	ZTX558	ZTX1048A
BC414BP	BFQ31	FMMV2105	ZC832A	ZTX649	ZTX1049A
BC415AP	BFS17	FMMV2106	ZC833A	ZTX650	ZTX1051A
BC416AP	FCX458	FMMV2107	ZC834A	ZTX651	ZTX1053A
BC546BP	FCX558	FMMV2108	ZC835A	ZTX653	ZTX1055A
BC547BP	FMMD914	FMMV2109	ZC836A	ZTX657	ZTX1056A
BC548BP	FMMD2835	FMMV3102	ZDX1F	ZTX658	

Description

This library contains through hole footprints for all types of component.

It is vital to check that all pad and drill hole sizes are suitable for your own manufacturing process before raising orders for large numbers of boards.

Diodes

DIODE packs
Equivalent packs are in brackets.

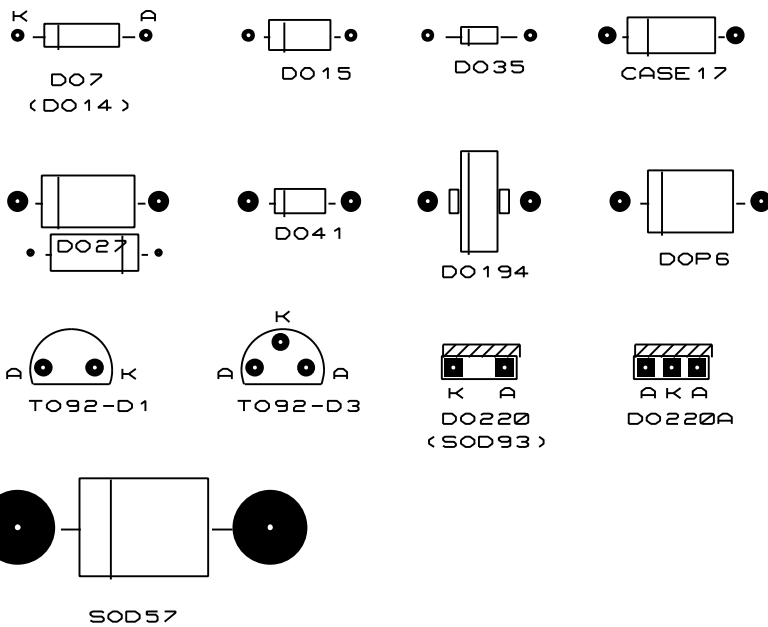

BRIDGE RECTIFIER packs

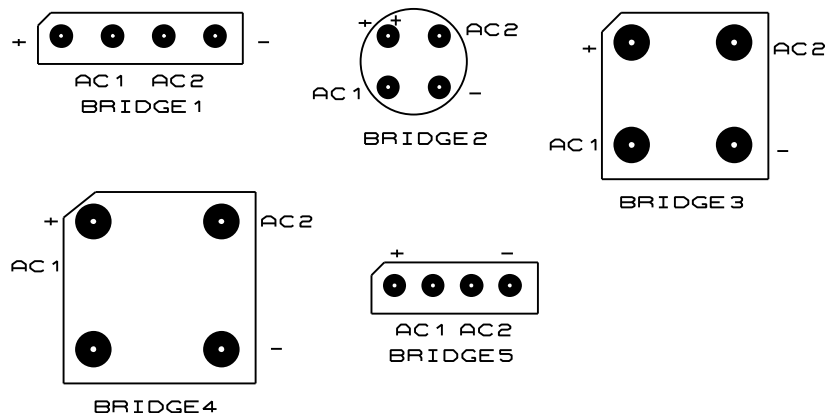

Transistors

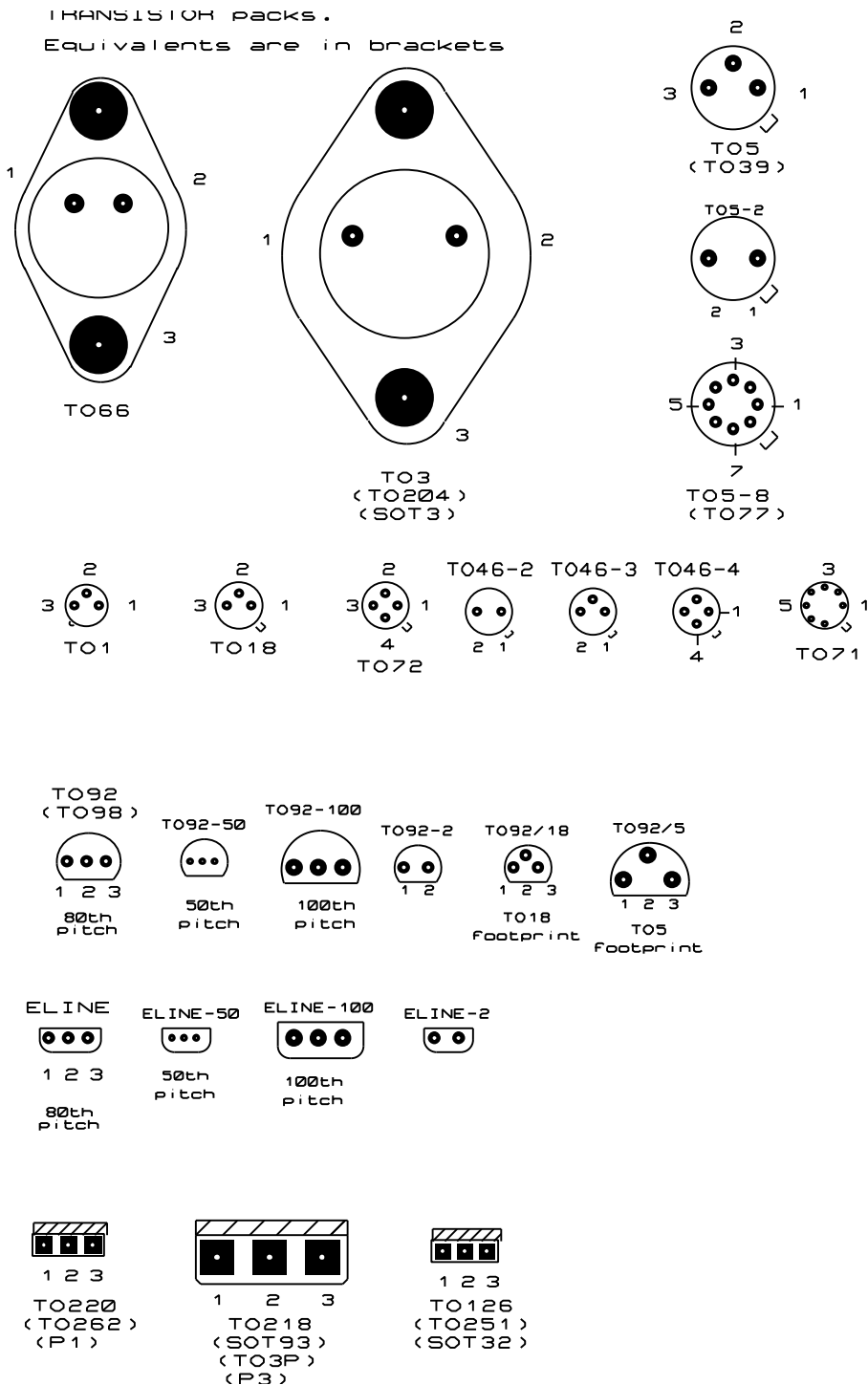

Note that all transistor packs now use pin numbers – this allows several differently pinned devices in ISIS to use the same footprint.

Connectors

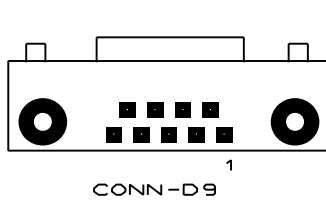

CONN-D9

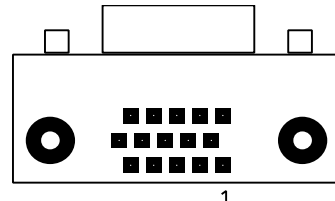

CONN-D15S

Also - 15, 25, 37 way.

NOTE : Pin numbering is for sockets.

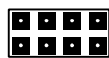

CONN-DIL8

ALSO - 10, 14, 16, 20, 26, 30, 34, 40, 50, 60 way



CONN-SIL8

ALSO - 1, 2, 3, 4, 5, 6, 7, 8, 9, 10, 12 way.

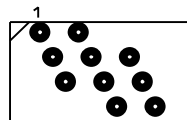

4RHEAD-10

ALSO - 16, 20, 26, 34, 40, 50 way.

TERMINAL BLOCK packs

Metric types - pin space 5mm



TBLOCK-M12
ALSO 2, 3, 4, 6 WAY

Imperial types - pin space 0.2"

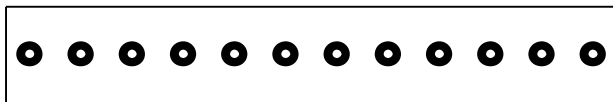

TBLOCK-I12
ALSO 2, 3, 4, 5, 8 WAY

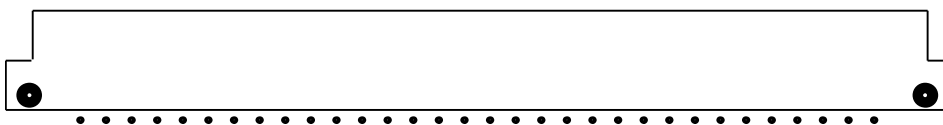

DIN 41612
Also 64 and 96 way

Passives

RESISTORS



Capacitors

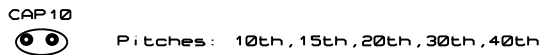

Axial Electrolytics

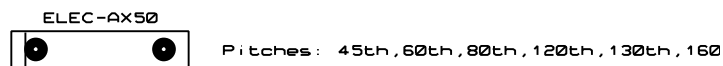

Radial Electrolytics



PRESET packs .

Skeleton types .

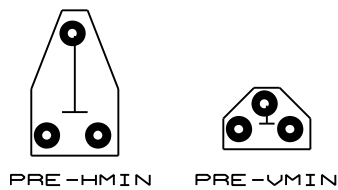

WIRE LINKS

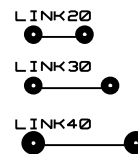

SQUARE types

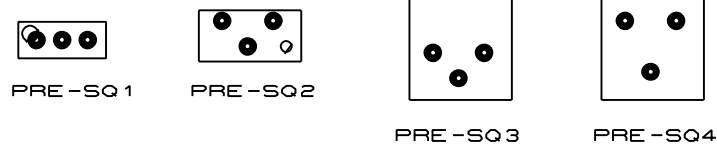

3/4" & 1/1/4" MULTI TURN types

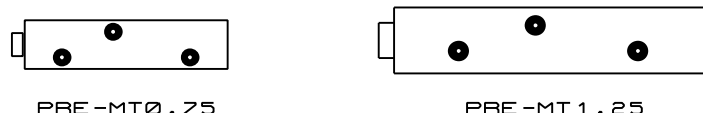

IC Packs

DUAL IN LINE

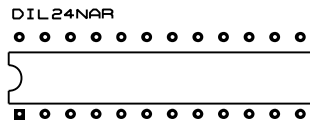
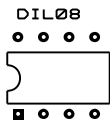

ALSO 6, 8, 14, 16, 18, 24, 28, 40, 48, 64 PIN.

LEADED CHIP CARRIER SOCKETS

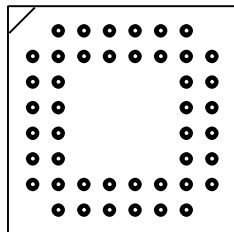

LCC-SKT44
ALSO 28, 32, 52, 68, 84 PIN

Miscellaneous

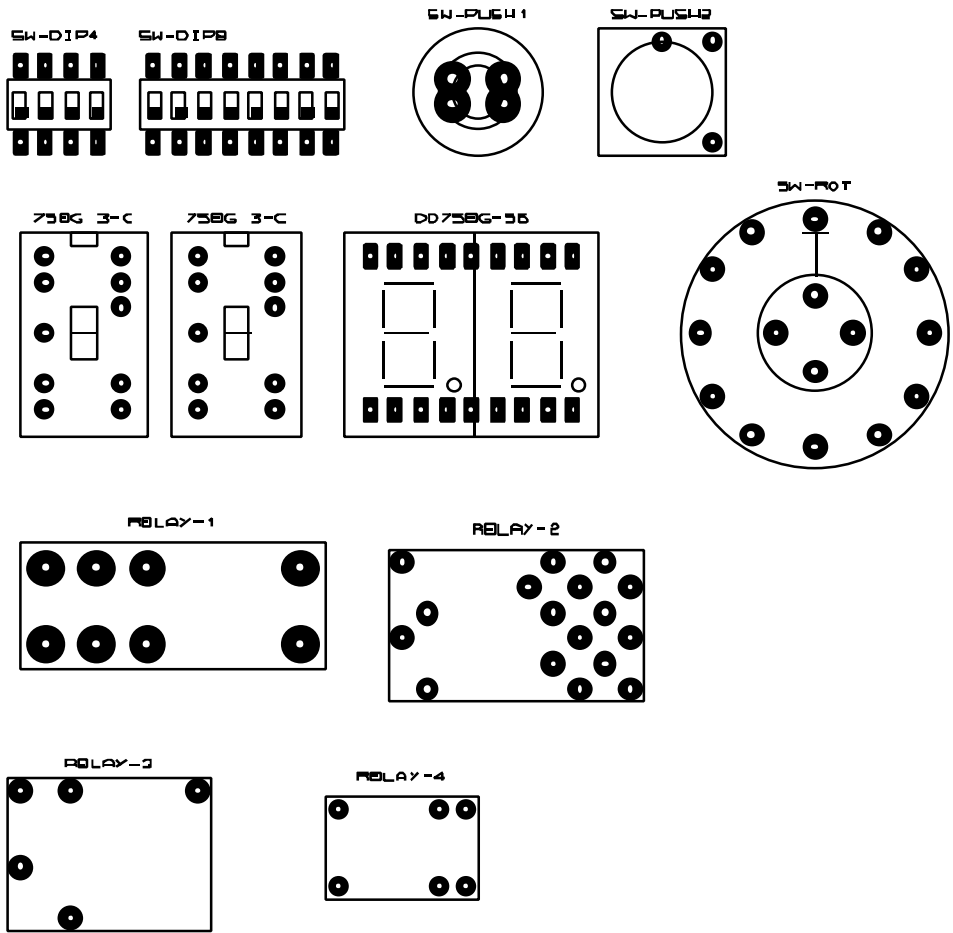

Description

This library contains footprints for discrete surface mount devices – resistors, capacitors, diodes and transistors. All footprints in this library are designs for reflow soldering.

It is vital to check that pad sizes and spacing are suitable for your own manufacturing process before raising orders for large numbers of boards.

Diodes

DIODE packs - two pin.

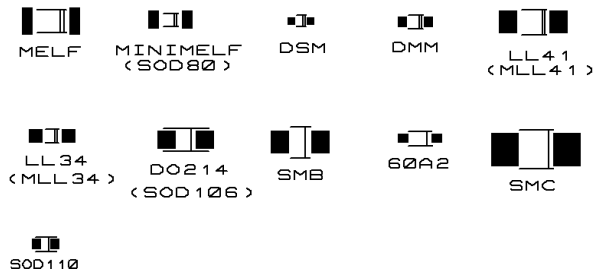

DIODE Multi-packs.



SOT23 (with suffix)

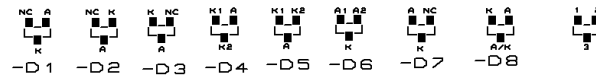

UMD

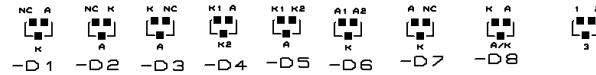

SC59



EM3



SOT89



DKAK

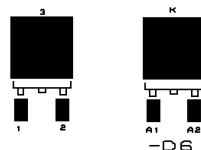

SOT223-D1



Transistors

SMT SIGNAL TRANSISTORS



SMT POWER TRANSISTORS

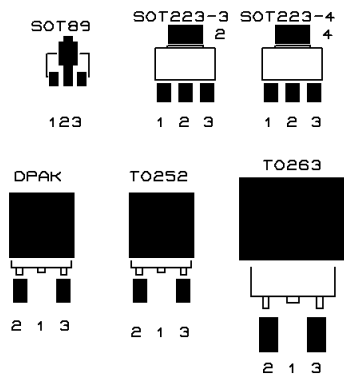

All the transistor packs have pin numbers (rather than names) so that devices in ISIS with different pinnings – especially Bipolars and FETs can use the same footprint.



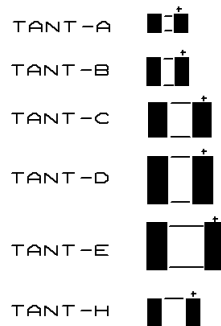









Tantalum Capacitors



Tantalum capacitors are often available in rectangular packs with leads folded under the end. We have adopted the names used by Hitachi in their TMC range. The following table gives equivalents for other manufacturers.

Typical Size (mm)	Hitachi TMC	AVX TAJ	Siemens B45196	Kemet T491	Natpan ECST	NEC NR	Sprague 293D	Mial
3.2x1.6	A	A	A	Y	A	A	-	A
3.5x2.8	B	B	B	B	X	B2	B	B
4.8x2.6	H	-	-	-	B	B	-	-
5.8x4.5	D	-	-	-	-	-	E	-
6.0x3.2	C	C	C	C	C	C	C	C
7.3x4.3	E	D	D	D	D	D	D	D/D0

Chip Capacitors and Resistors

0402	
0603	
0805	
1206	
1210	
1812	
2010	
2220	
2225	
2512	
2824	
3827	

Only chip outlines are supplied. Other packages that are used may be copied from the diode packages and renamed with pins numbered '1' and '2' instead of 'K' and 'A'. The following chip sizes are supplied: 0402, 0603, 0805, 1206, 1210, 1812, 2010, 2220, 2225, 2512, 2824, 3827. These packs are also used extensively in ceramic chip capacitors. The packs are drawn with the pad width approximately the same width as the chip. The landing zone (length of pad exposed past the ends of chip) is not excessive, to allow close packing of components. This may make the pads inappropriate for tall chip components or placement machines that are not of very fine tolerance. If a few more thou are needed on the ends of the chip for more reliable construction with your board manufacturer, it is acceptable to increase the pad sizes without moving the centres. Note also that the maximum track size between the pads and packing density are limited. In general allow at least 15 thou clearance around the pads, but again it is best to check with your board manufacturer.



Most surface mount crystals share the same footprint (EAIJ-1009B or EIA-418A) so this is supplied with the name XTAL.

Electrolytic Capacitors

Nichicon footprints.
No data on equivalents.

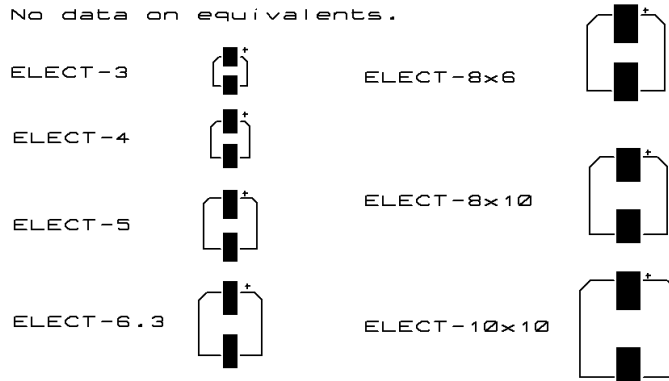

Nippon Chemi-Con MF & MFK series.
No data on equivalents.

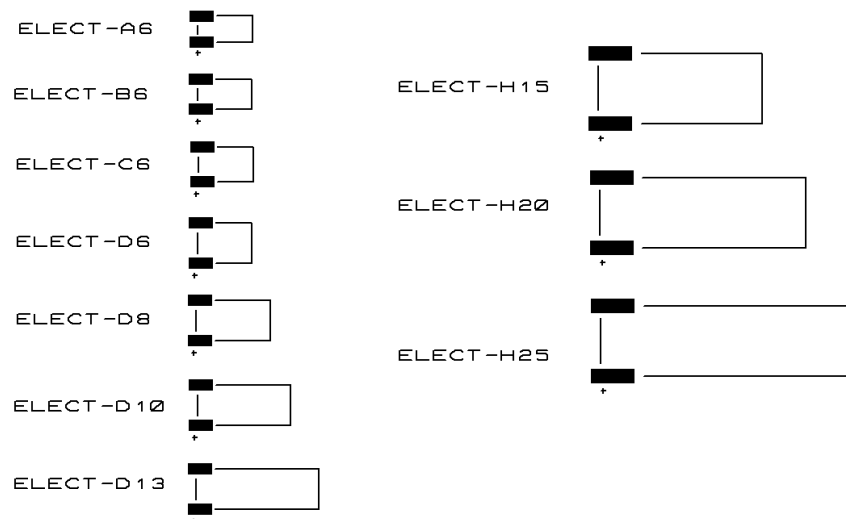

Two electrolytic capacitor families are supplied. No data on equivalent packages was available at the time this library was drawn up. Nichicon electrolytics have a vertical can on a square base. The ranges UP, UR, UX, UT, UZ, WX are supported. Packages supplied are : ELECT-3, ELECT-4, ELECT-5, ELECT-6.3, ELECT-8X8, ELECT-8X10, ELECT-10X10.

Nippon Chemi-Con are rectangular with the connections at one end. The outlines supplied are : ELECT-A6, ELECT-B6, ELECT-C6, ELECT-D6, ELECT-D8, ELECT-D10, ELECT-D13, ELECT-H15, ELECT-H20, ELECT-H25.

PLCC – Plastic Leaded Chip Carrier

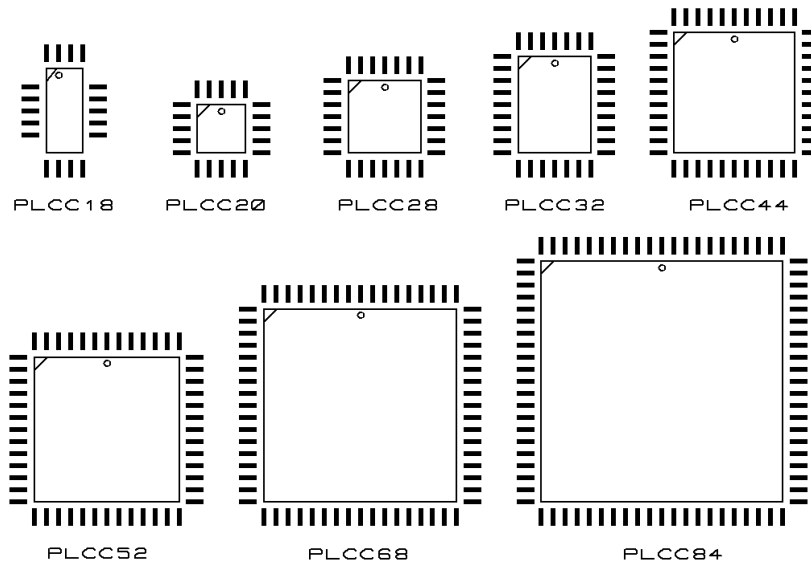

Motorola recommended pad sizes. N.B. Mitsubishi recommend smaller pads (50x30 thou) but have the same distances between the inner edges.

CLCC – Ceramic Leaded Chip Carrier

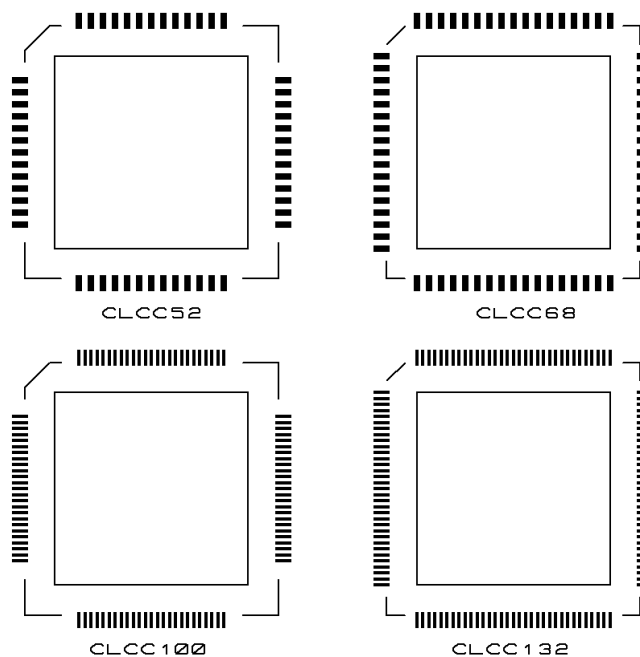

JEDEC standard parts. Pins on 25 or 50 thou and chip mount plate always 0.95 in. sq.

SOP – Small Outline Packs

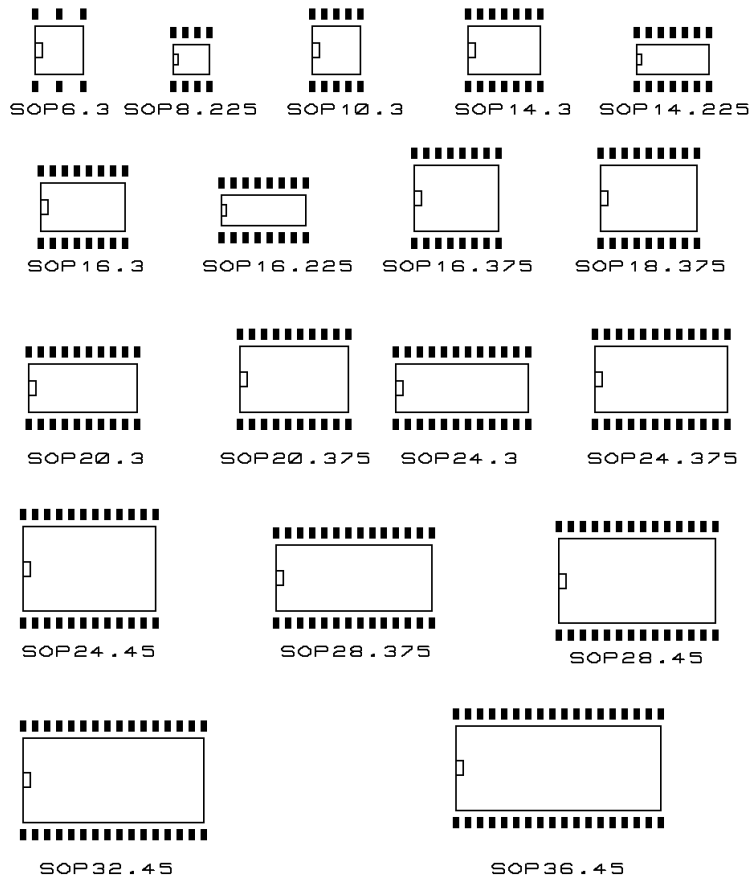

Naming scheme represents number of pins in pack, then row spacing in inches.

VSOP – Very Small Outline Pack



These two packs are used by IDT and are part of the JEDEC standard. They have pins on a 25 thou pitch. IDT calls them Shrink SOPs, but this could cause confusion with the SSO parts in this library.

SOJ – Small Outline J-lead

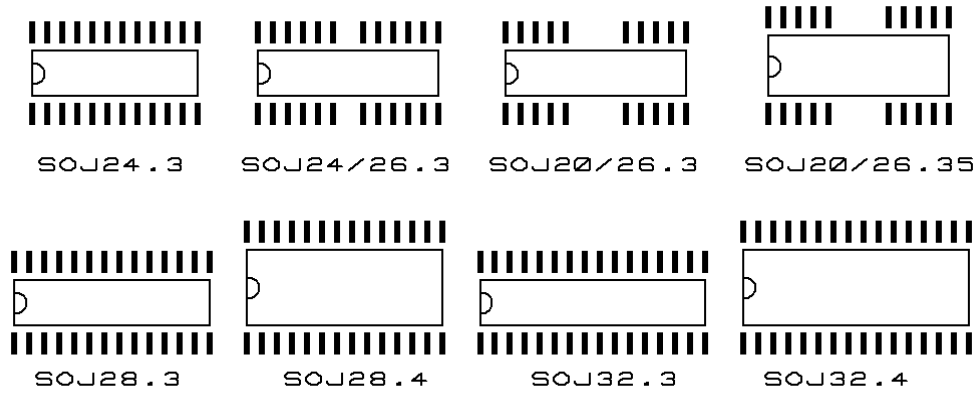

These packages are named by the number of pins, and then the pitch between rows in inches.

SSO – Shrink Small Outline Packs

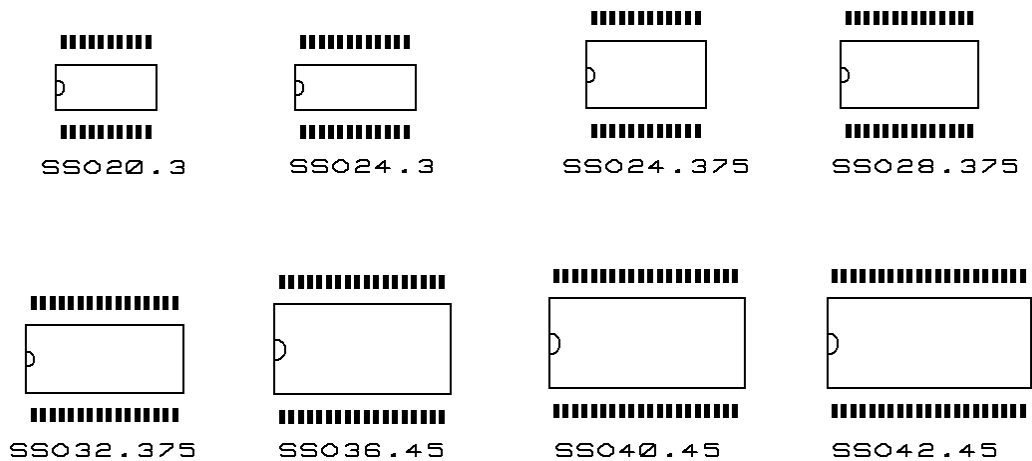

Pins are spaced by 0.8mm. Naming indicates number of pins, then rows spacing in inches.

QFP – Quad Flat Packs (Standard)

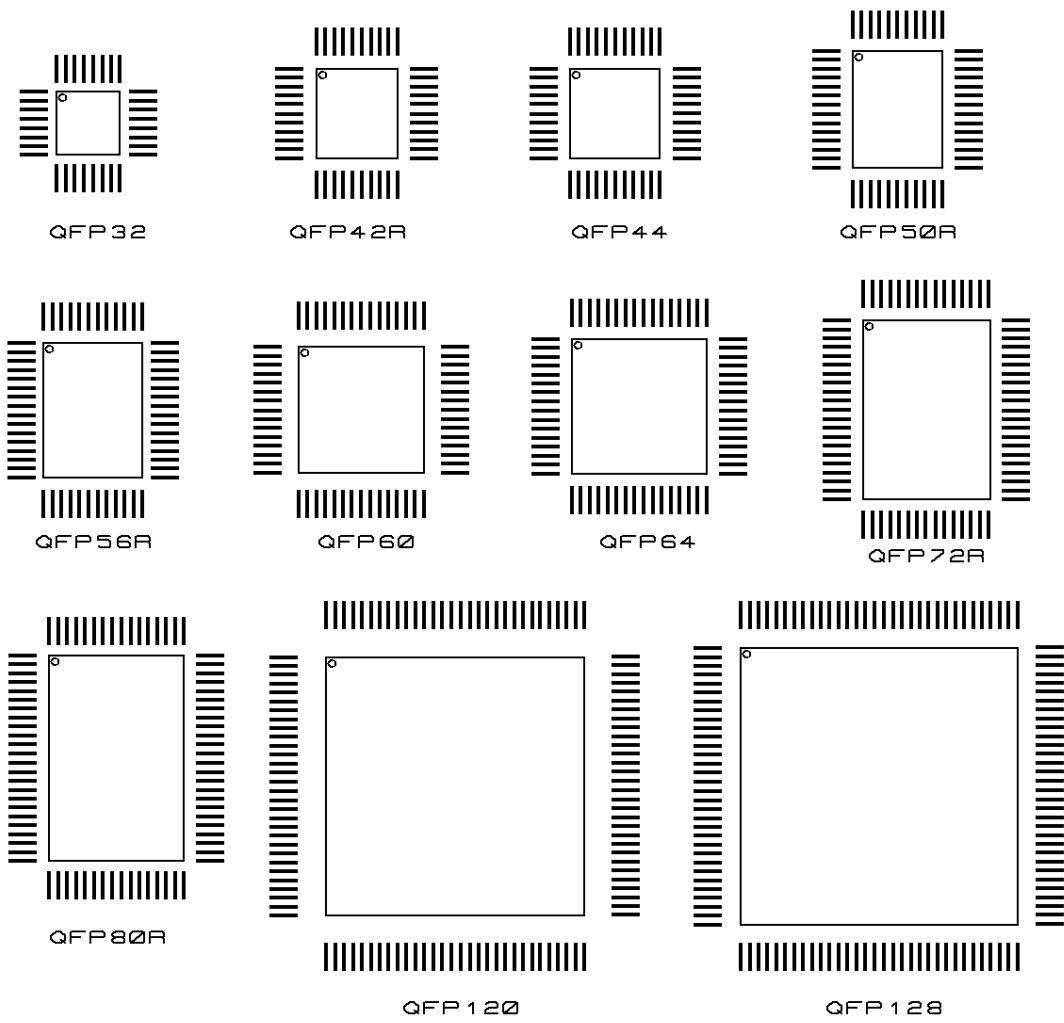

These parts have 0.8mm pin spacing. 'R' suffix denotes rectangular arrangement.

QFP – Quad Flat Packs (Wide)

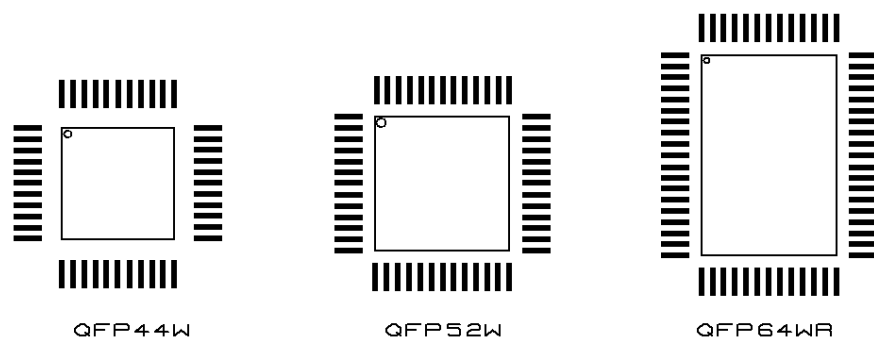

This parts have 1mm pin spacing denoted by 'W' suffix.

QFP – Quad Flat Packs (Narrow)

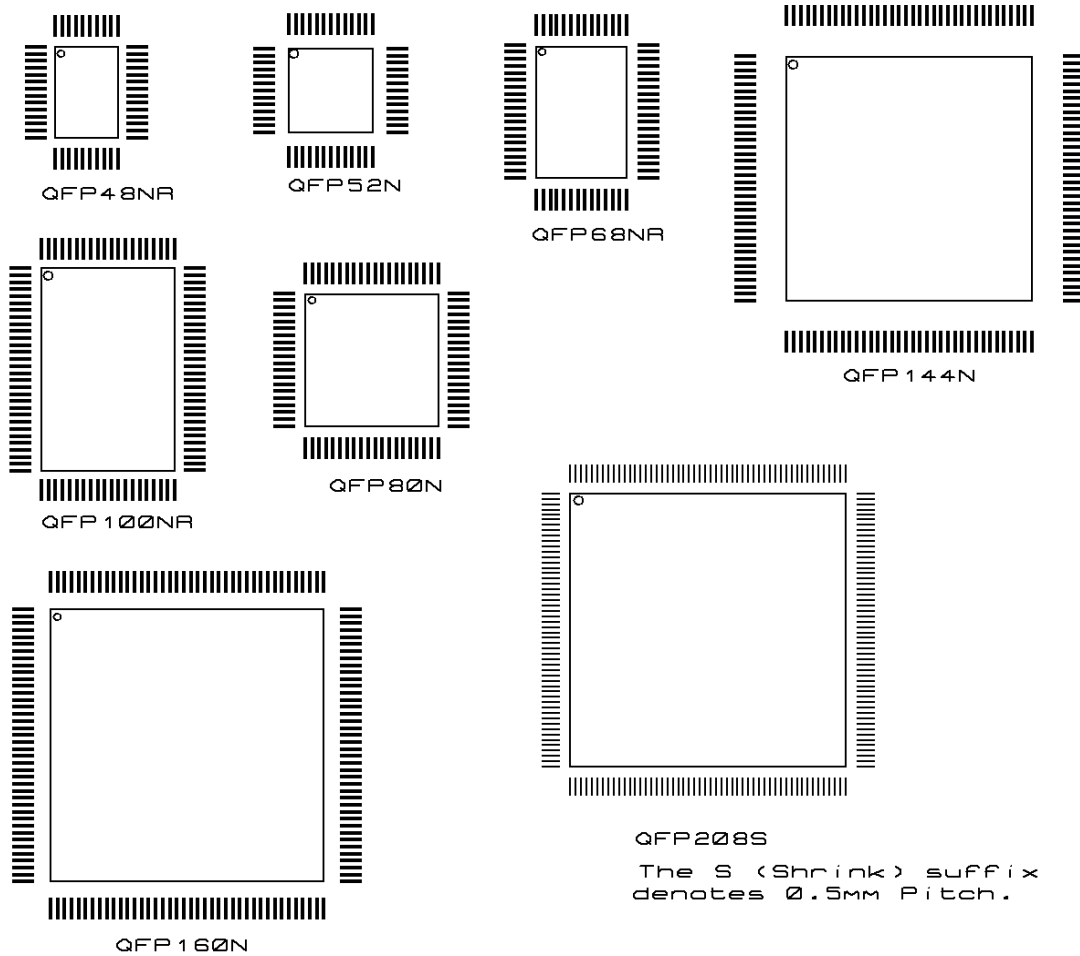

These parts have 0.65mm pin spacing except for 'S' types which have 0.5mm spacing. 'R' suffix denotes rectangular arrangement.

PQFP – Plastic Quad Flat Packs

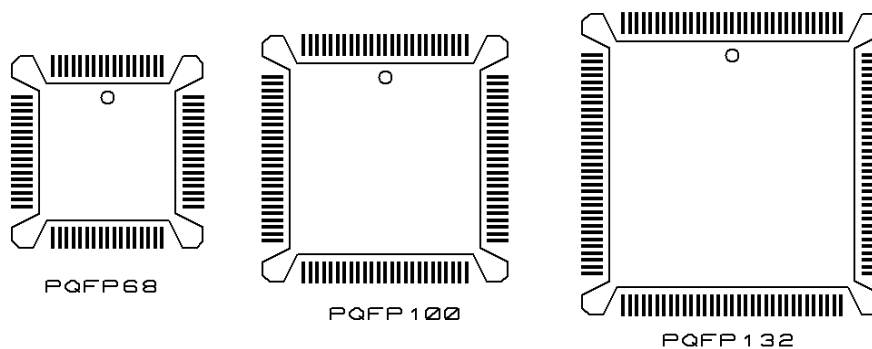

Pad dimensions source from Motorola.